

Vortex type high pressure Series Gust Blower

# U2G Series

domestically and internationally.

Compatible with high-efficiency regulations both



Discharge characteristic maximum static pressure  
**24** kPa







Moving in new ways.  
— MAGOKORO Company —



# Clears the world's high-efficiency regulations

Suitable for a wide range of applications, useful in all situations!

## High-efficiency regulations/overseas safety standards

Japan	China	USA	Europe/UK
<b>Top Runner Standard (IE3)</b>  JISC4034-30 (IE3 efficiency standard)	<b>High efficiency regulation GB3 class &amp; CCC</b>  GB18613-2020 GB3 (IE3) (3.7kW is not subject to CCC)	<b>UL Standard &amp; NEMA Premium (208-230 460V60Hz)</b>  UL1004-1&NEMA Premium (IE3) CC.NO.CC302B	<b>CE marking UKCA marking</b>  RoHS2 Directive

We added products that comply with overseas regulations to our Gust Blower lineup!



## U2G Specification Table

Compatible certification	Model	Phase	Output kW	Frequency Hz	Voltage V	Suction characteristics		Discharge characteristics		Suction characteristics		Discharge characteristics		Noise level 1.5m dB(A)	Starting current A	Weight kg
						Current (reference) A	Current A	Maximum air volume m <sup>3</sup> /min	Maximum static pressure kPa	Maximum air volume m <sup>3</sup> /min	Maximum static pressure kPa					
UK UKCA European CE (as a product)	U2G-70T	3	0.75	50	200	2.5	2.6	2.4	9.8	2.4	10.8	61	25.5	22.5		
				60	200 / 220 / 230	3.3 / 3.2 / 3.2	3.6 / 3.4 / 3.3	2.8	12.8	2.8	14.9	64.5	23.0 / 25.5 / 26.5			
	U2G-150	3	1.5	50	200	5.1	5.9	3.5	12.8	3.5	15	65.5	63.0	33		
				60	200 / 220 / 230	6.8 / 6.7 / 6.7	7.9 / 7.4 / 7.4	4.2	16.4	4.2	18.3	68.5	56.0 / 62.0 / 65.0			
	U2G-370A	3	3.7	50	200	9.0	10.0	4.6	15.8	4.6	18	67.5	155.0	48		
				60	200 / 220 / 230	10.5 / 10.5 / 11.0	13.0 / 12.3 / 12.0	5.5	20.3	5.5	24	70	132.0 / 145.0 / 152			
	U2G-370B	3	3.7	50	200	11.2	12.3	7.3	18.2	7.3	20.5	68.5	155.0	55		
				60	200 / 220 / 230	14.0 / 13.5 / 13.2	16.3 / 15.3 / 15.0	8.7	21.8	8.7	24.2	72.5	132.0 / 145.0 / 152.0			
	U2G-70T(400V)	3	0.75	50	380 / 400	1.3 / 1.3	1.3 / 1.3	2.4	9.8	2.4	10.8	61	12.1 / 12.8	22.5		
				60	400 / 440 / 460	1.7 / 1.6 / 1.6	1.8 / 1.7 / 1.7	2.8	12.8	2.8	14.9	64.5	11.5 / 12.7 / 13.3			
U2G-150(400V)	3	1.5	50	380 / 400	2.6 / 2.6	2.9 / 3.0	3.5	12.8	3.5	15	65.5	30.0 / 31.5	33			
			60	400 / 440 / 460	3.4 / 3.3 / 3.3	4.0 / 3.7 / 3.7	4.2	16.4	4.2	18.3	68.5	28.0 / 31.0 / 32.5				
U2G-370A(400V)	3	3.7	50	380 / 400	4.2 / 4.5	4.9 / 5.0	4.6	15.8	4.6	18	67.5	73.5 / 77.5	48			
			60	400 / 440 / 460	5.4 / 5.4 / 5.5	6.5 / 6.2 / 6.0	5.5	20.3	5.5	24	70	66.0 / 72.5 / 76.0				
U2G-370B(400V)	3	3.7	50	380 / 400	5.6 / 5.6	6.2 / 6.2	7.3	18.2	7.3	20.5	68.5	73.5 / 77.5	55			
			60	400 / 440 / 460	7.0 / 6.6 / 6.6	8.2 / 7.7 / 7.5	8.7	21.8	8.7	24.2	72.5	66.0 / 72.5 / 76.0				
China CCC/GB (Motor part only) (3.7kW is not covered by CCC)	U2G-70TC	3	0.75	50	200	2.5	2.6	2.4	9.8	2.4	10.8	61	25.5	22.5		
	U2G-150C	3	1.5			5.1	5.9	3.5	12.8	3.5	15	65.5	63.0	33		
	U2G-370AC	3	3.7			9.0	10.0	4.6	15.8	4.6	18	67.5	155.0	48		
	U2G-370BC	3	3.7			11.2	12.3	7.3	18.2	7.3	20.5	68.5	155.0	55		
	U2G-70TC(380V)	3	0.75	50	380	1.3	1.3	2.4	9.8	2.4	10.8	61	12.1	22.5		
	U2G-150C(380V)	3	1.5			2.6	2.9	3.5	12.8	3.5	15	65.5	30.0	33		
	U2G-370AC(380V)	3	3.7			4.2	4.9	4.6	15.8	4.6	18	67.5	73.5	48		
U2G-370BC(380V)	3	3.7	5.6			6.2	7.3	18.2	7.3	20.5	68.5	73.5	55			
USA UL NEMA PREMIUM (Motor section only)	U2G-70TU	3	0.75	60	208 / 230 / 460	3.1 / 2.9 / 1.5	3.4 / 3.2 / 1.6	2.8	12.8	2.8	14.9	64.5	22.5 / 25.0 / 12.5	22.5		
	U2G-150U	3	1.5		208 / 230 / 460	6.0 / 5.7 / 2.9	6.9 / 6.4 / 3.2	4.2	16.4	4.2	18.3	68.5	51.0 / 57.0 / 28.5	33		
	U2G-370AU	3	3.7		208 / 230 / 460	10.0 / 10.0 / 4.9	11.5 / 11.0 / 5.6	5.5	20.3	5.5	24	70	130.0 / 150.0 / 75.0	48		
	U2G-370BU	3	3.7		208 / 230 / 460	14.0 / 13.5 / 6.3	16.0 / 15.0 / 7.5	8.7	21.8	8.7	24.2 <sup>*1</sup>	72.5	130.0 / 150.0 / 75.0	55		

\*Contact us to inquire about the availability of different voltages and special specifications other than those listed.

\*1:U2G-370BU (208V60Hz) Discharge performance maximum static pressure 22.5kPa

# Performance Curve

— Discharge performance

— Intake performance

U2G-70T

U2G-70TC (50Hz)

U2G-70TU (60Hz)

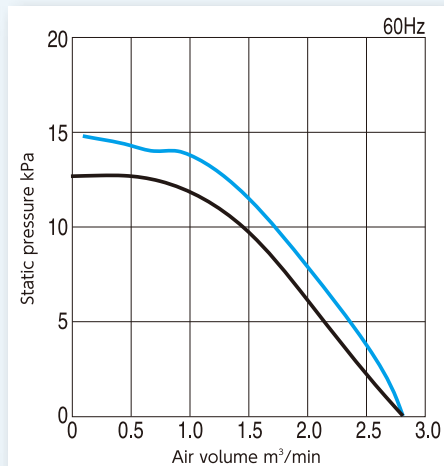
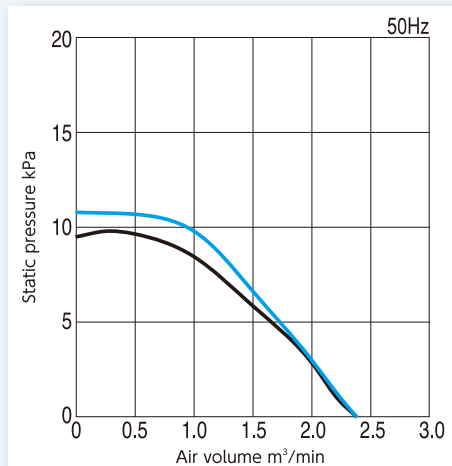

U2G-150

U2G-150C (50Hz)

U2G-150U (60Hz)

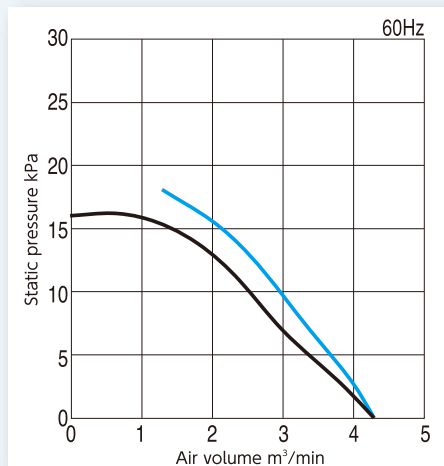
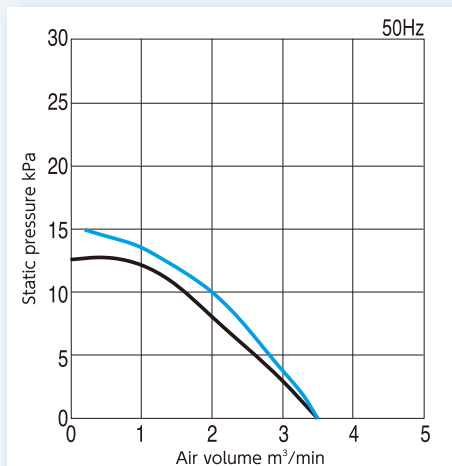

U2G-370A

U2G-370AC (50Hz)

U2G-370AU (60Hz)

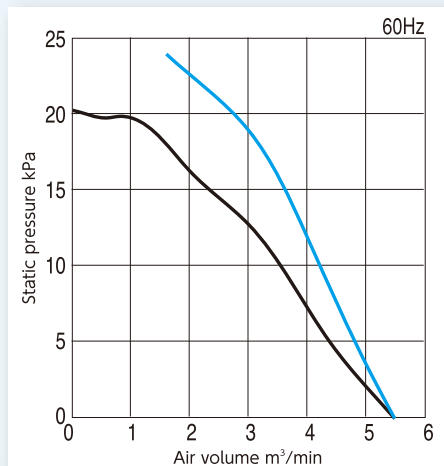
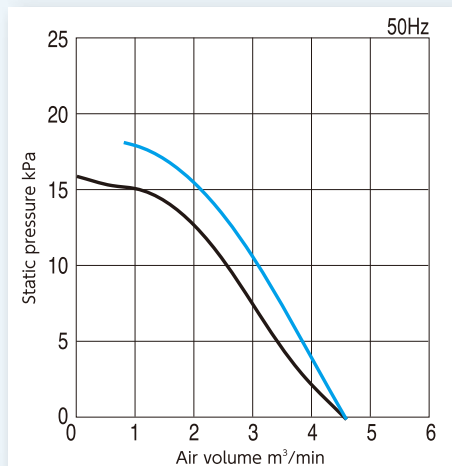

U2G-370B

U2G-370BC (50Hz)

U2G-370BU (60Hz)

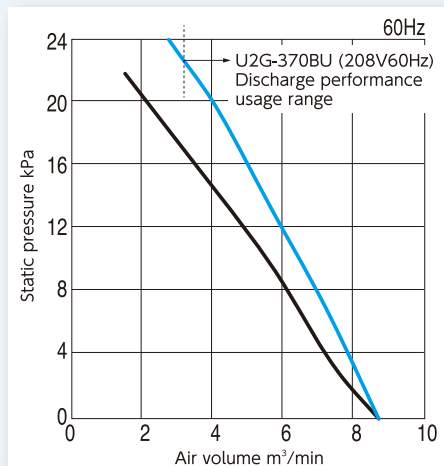
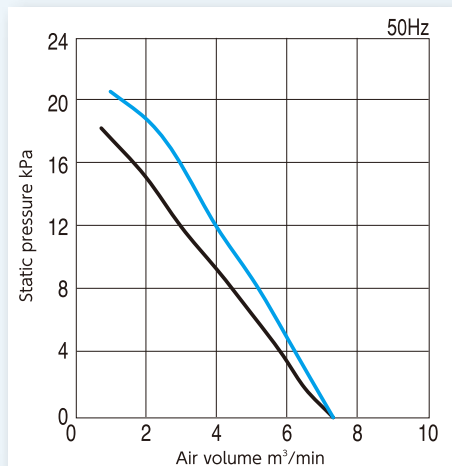

# External Dimension Drawing

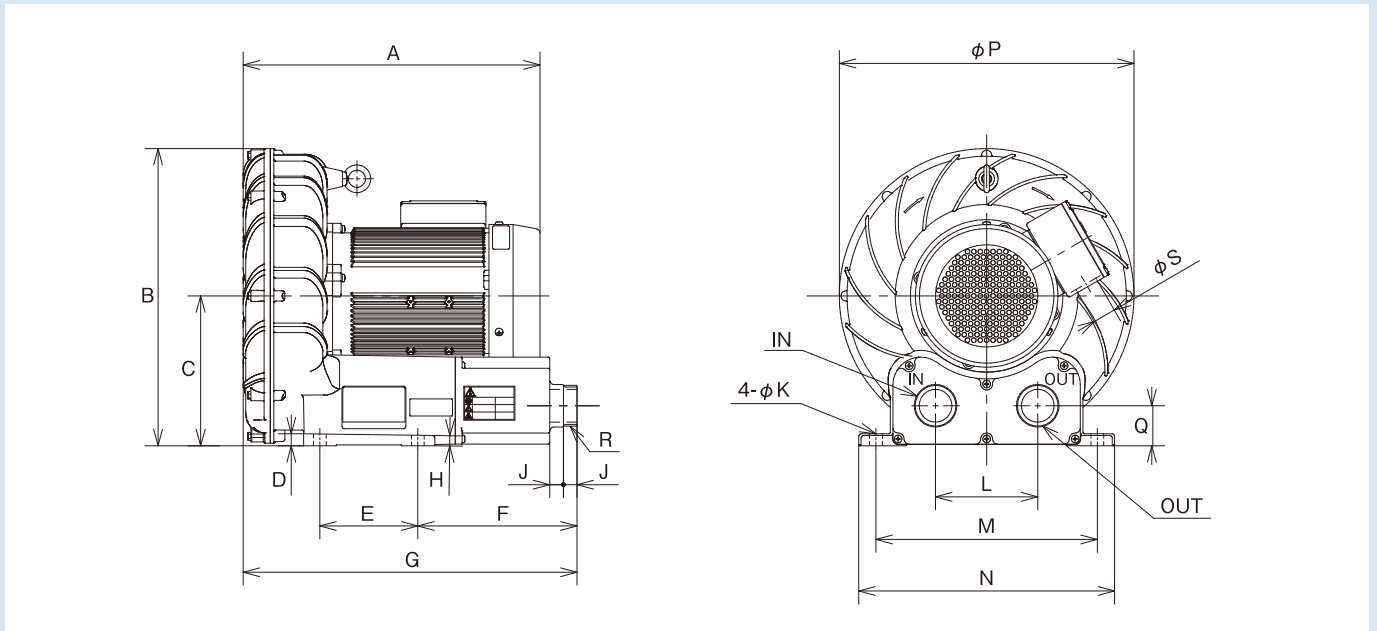

## U2G Series External Dimension Drawing

Unit:mm

Model	A	B	C	D	E	F	G	H	J
U2G-70T / U2G-70TC / U2G-70TU	307	305	156	14	95	159	333	12	16
U2G-150 / U2G-150C / U2G-150U	349	349	176	14	115	187	392	12	16
U2G-370A / U2G-370AC / U2G-370AU	403	384	193	18	140	202	440	15	18
U2G-370B / U2G-370BC / U2G-370BU	409	443	234	15	140	146	463	15	0

Model	K	L	M	N	P	Q	R	S
U2G-70T / U2G-70TC / U2G-70TU	12	110	225	260	298	44	R1-1/2	22
U2G-150 / U2G-150C / U2G-150U	15	120	260	300	346	47	R1-1/2	27
U2G-370A / U2G-370AC / U2G-370AU	15	125	290	331	382	52	R2	27
U2G-370B / U2G-370BC / U2G-370BU	15	125	300	335	418	64	Rp2	27

## Application Example

### Air table

The air pumps through small holes, making heavy goods move with ease.

### Air layer conveyor

Air is sent from the bottom to float and move the powder.

### Washing machine (Blowing off water droplets)

Blow away the water droplets on the product.

### Automatic cutting machine (Fabric fixation)

Suction and fix the stacked cloth and cut it with a cutter.



Engineering Company  
<https://www.showadenki.co.jp/en>

showadenki Search

