



# BLOWER COMPREHENSIVE CATALOG

Moving in new ways.

— MAGOKORO Company —

# Showa Denki Products Introduction

Turbo type & Sirocco type

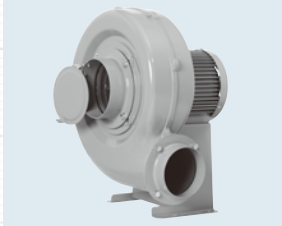

EC-H07

Plate type



EP-H10

Sirocco type

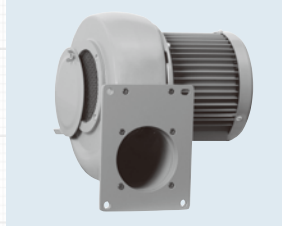

FS-H04

Sirocco type

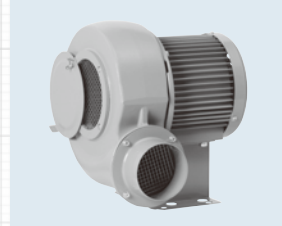

FSM-H04

Compact series

Multi series

Turbo type

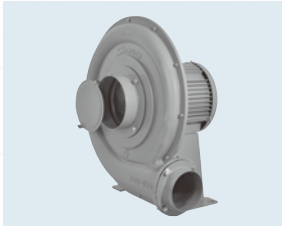

KSB-H07

Sirocco type



SB-201

Airfoil type

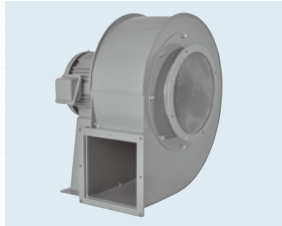

AH-H22

Turbo type



U100B-H26

High pressure series

General purpose series

Low noise series

Multi-stage series

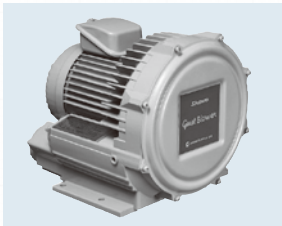

U2V

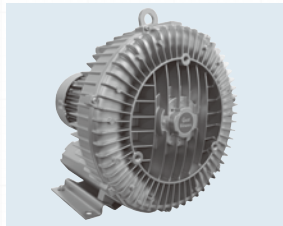

U2S

High pressure series Gust blower



Denchoku

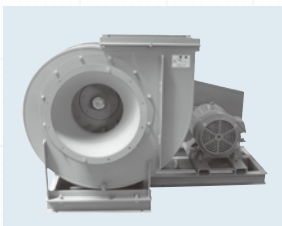

Turbo type Delturbo T1V · T2V  
High pressure and high efficiency

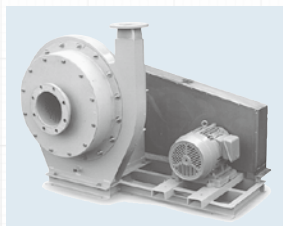

Turbo type B2V · B3V  
High pressure and high efficiency

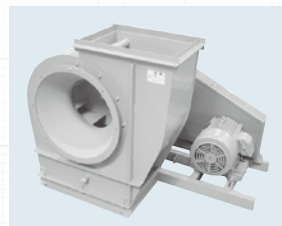

Airfoil type KT  
Low noise

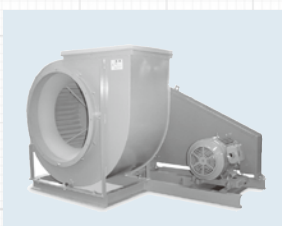

Sirocco type M1V  
Large air volume

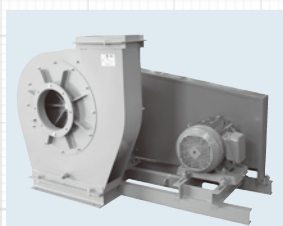

Plate type P1V · GP  
In case of dust or powder



Axial flow type A1D · A2D

## Contents

Blower structure

Page

4

Page

5

Impeller type

Blower air volume and  
Pressure & How to read  
performance curve diagrams

Page

6

Page

7

Electric blower

Application example

Page

16

Page

17

Denchoku  
(Direct Drive Blower)

V-belt drive blower

Page

20

Page

25

Custom order products

Contact information

Page

30

Page

31

Website introduction

# Blower structure

A blower applies energy to gas through the rotational movement of an impeller. Simply put, the impeller rotates inside the casing to apply pressure to gas and generate wind.

Fig. 1. In an electric blower directly connected to the motor shaft, the impeller that is directly connected to the motor shaft rotates due to the rotation of the motor and sends out the wind from the discharge port of the casing.

## Finished product



It's compact!

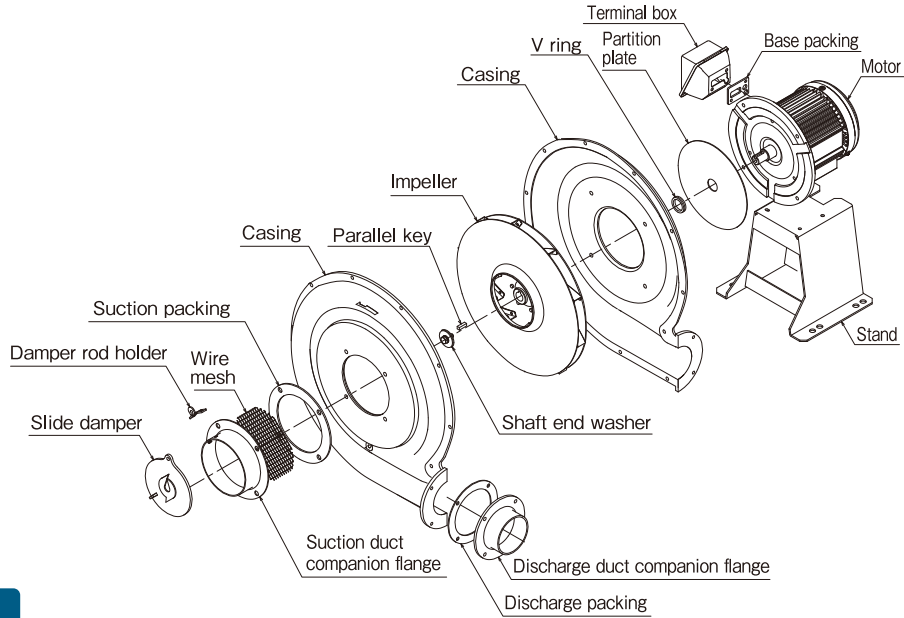
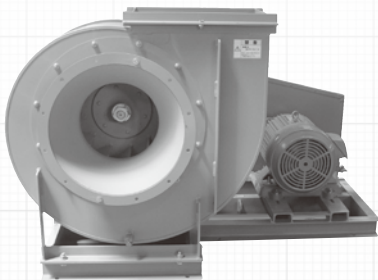

Fig.1: Electric blower with direct-connect motor Internal structural diagram

Fig. 2. The V-belt drive type blower transmits the rotation of the motor to the impeller with the V-belt and blows out wind.

## Finished product



You can change the revolution speed!

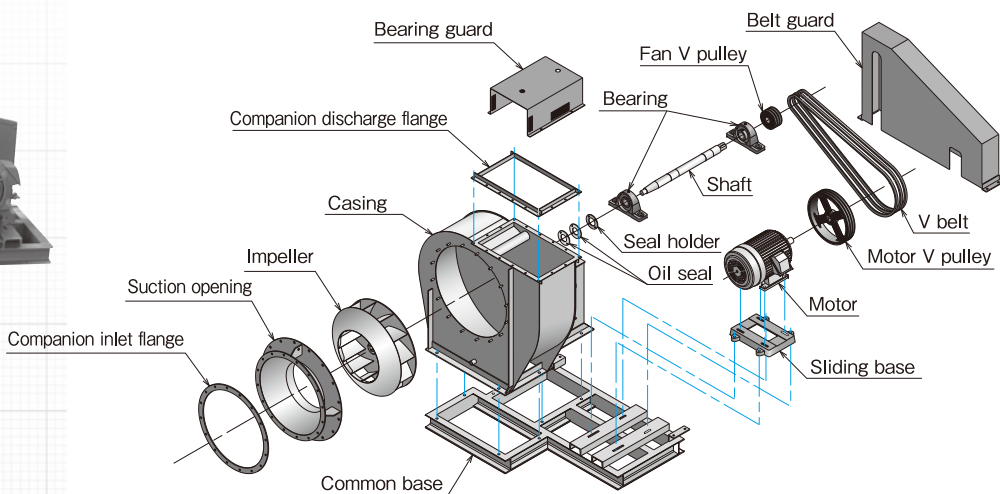
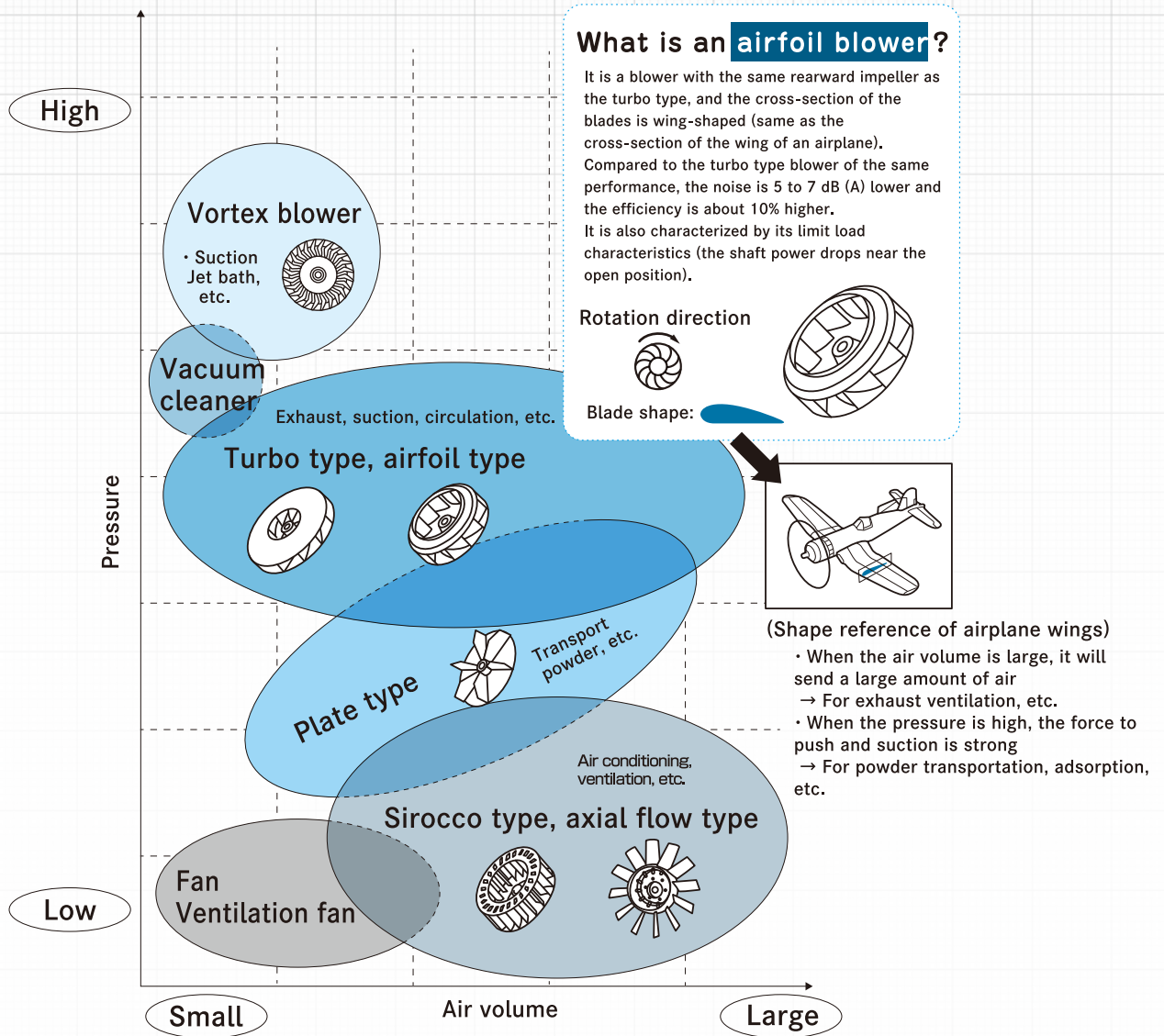

Fig.2: V belt-drive electric blower internal structural diagram

# Impeller type



## Shape of the impeller

Impeller shape	Characteristic	Shape	Impeller rotation direction
Sirocco	Also called a multi-blade blower, a constant air volume is obtained in a centrifugal blower. It is the smallest to use, but it is less efficient and more noisy than turbos and airfoils.		
Turbo	Because the blades are turned backward to the direction of rotation to reduce resistance, the efficiency is good, and the noise is low. It can be used in a high range of both air volume and static pressure. The E series ranges from the sirocco to the turbo style.		
Airfoil	It's a type of turbo, but it's most efficient, and makes significantly less noise, because its blades are shaped like the wings of an airplane or bird.		
Plate	It is less efficient than a turbo or airfoil, but the impeller structure is simple and it is suitable for situations that contain dust or powder.		
Axial flow	Compared to centrifugal blowers, the air volume is larger, and the static pressure is lower. Unlike centrifugal blowers, the flow of wind flows in the axial direction, and when the direction of rotation is reversed, the flow of wind is also reversed.		
Vortex	Compared to centrifugal blowers, it is smaller, lighter, and has higher pressure, making it suitable for applications with low air volume and high static pressure.		

## Blower air volume

The amount of air that the blower sucks in and exhales is called the air volume. Even for the discharge side of the blower, the amount converted to the suction state of the blower is called the air volume of the blower. The unit of volume is usually expressed in cubic meters ( $m^3$ ) but requires a unit of time for how long the volume is sent out, and when expressed for 1 minute, it is expressed in units of  $m^3/min$ ; for 1 hour, it is expressed as  $m^3/hr$ . A temperature of  $20^\circ C$ , an absolute pressure of  $101.3\text{ kPa}$ , a relative humidity of  $65\%$ , and an air density of  $1.2\text{ kg}/m^3$  are called standard air, and that state is called the standard state.

## Blower pressure (static pressure, dynamic pressure, total pressure)

There are three types of blower pressure: static pressure, dynamic pressure, and total pressure, and their relationship is "total pressure = static pressure + dynamic pressure".

Static pressure is the pressure exerted by gas on the surface of an object parallel to the flow of gas, and which is the pressure that pushes and inflates a balloon from inside the balloon when a rubber balloon or the like is inflated. When using a duct to send air from one place to another, it is the pressure required to overcome the resistance that occurs as it passes through the duct.

## How to read the performance curve

Example: Reading the performance curve of EC-H04 at 60Hz.

When the air volume is  $12\text{ m}^3/min$ , the air volume line ① and the curve of 60Hz intersect at ②, and if you read the intersection ③ of the static pressure axis from ②, you can see that the static pressure is  $1.0\text{ kPa}$ .

Also, if you extend upward from point ② on the performance curve, you reach the noise curve of 60Hz at ④, and can read the intersection ⑤ with the noise axis from ④ to see that the noise is  $78\text{dB (A)}$ .

All performance curves in this catalog are for performance at  $20^\circ C$ .

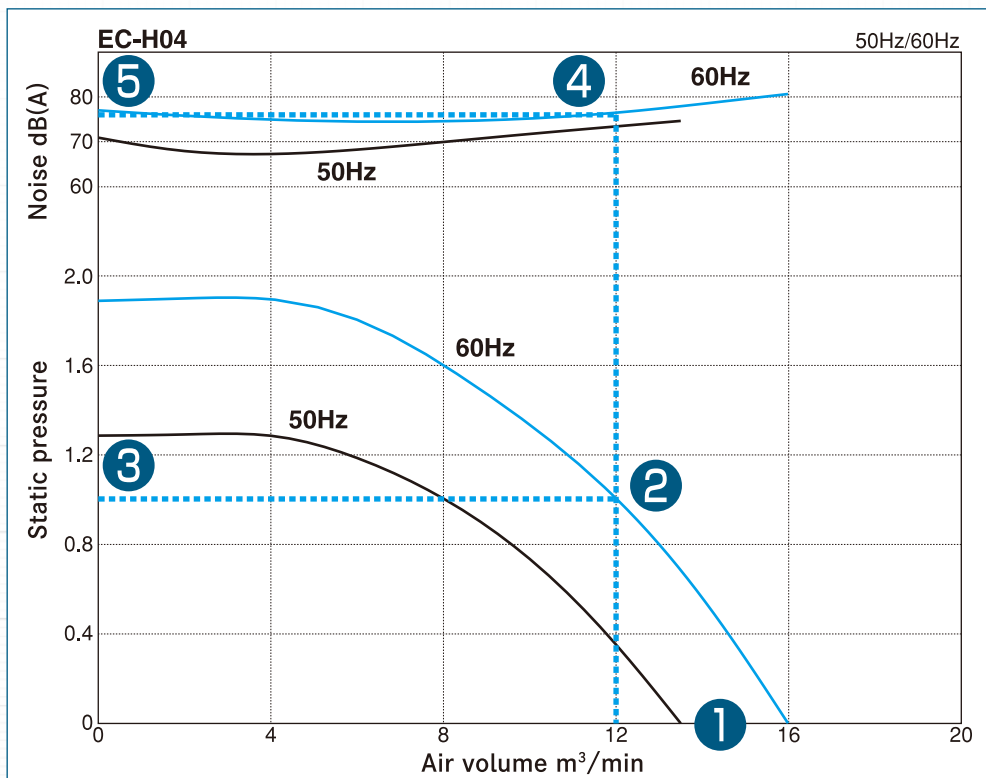

# Electric blower

## How to read electric blower model name

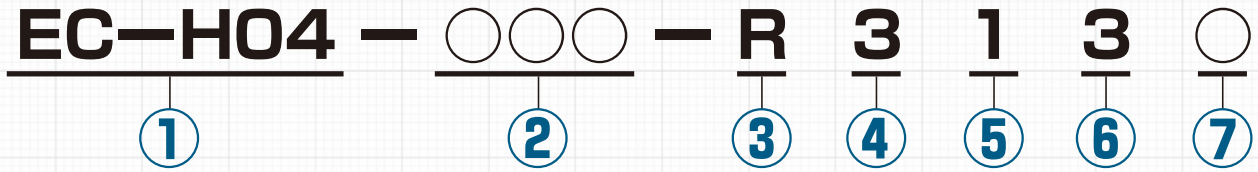

① Model name like in catalog

② Special order number :

If none, this is omitted.

③ Electric motor rotation (seen from the motor side)

Right : R (special order: M) Left : L (special order: H)

④ Outtake port direction

1 → Horizontal Up

2 → Vertical Up

3 → Horizontal down

※4 → Vertical down is special order

Right rotation



Left rotation



⑤ Phase and voltage

For single phase use alphabet

100V	A	200V	F
105V	B	210V	G
110V	C	220V	H
115V	D	230V	J
120V	E	240V	K

For 3 phase use number

Group 200V	1
Group 230V	2
Group 346V	3
Group 380V	4
Group 400V	5
Group 460V	6

There is possibilities for other voltage.

Explanation of 3 phase voltage group

Volt(V)	200	208	210	220	230	240	346	350	360	380	390	400	415	420	440	460	480	500	530	550
50 Hz																				
60 Hz																				
Group	Gr.200V			Gr.230V			Gr.346V			Gr.380V		Gr.400V			Gr.460V		Gr.500V		Gr.550V	

⑥ Frequency code

1 → 50 Hz    2 → 60 Hz    3 → 50/60 Hz

※ For standard products, except KSB and U models, frequency code is 3.

⑦ International Standard certification code for blower' s motor.

No certification.....no code

UL/CE certification.....U

GB (China) certification.....C

South Korea certification.....K

# Electric blower · Performance curves

The performance curves are displayed based on the blower series. Page 8 and 9 are for 50Hz. Please use when selecting a model.

## For 50Hz

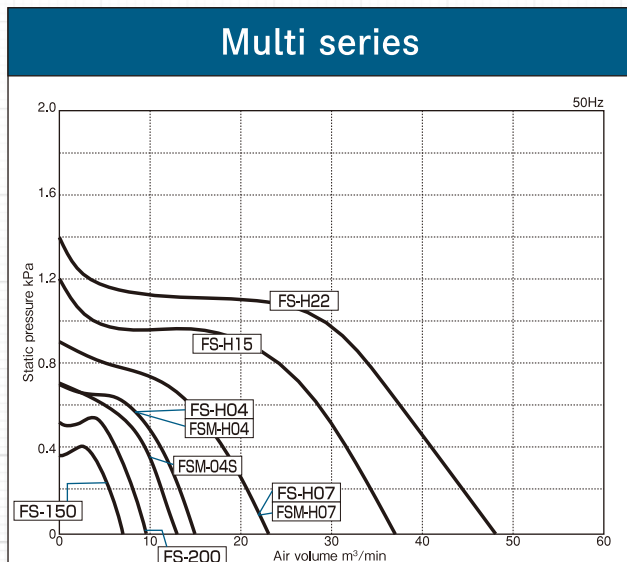
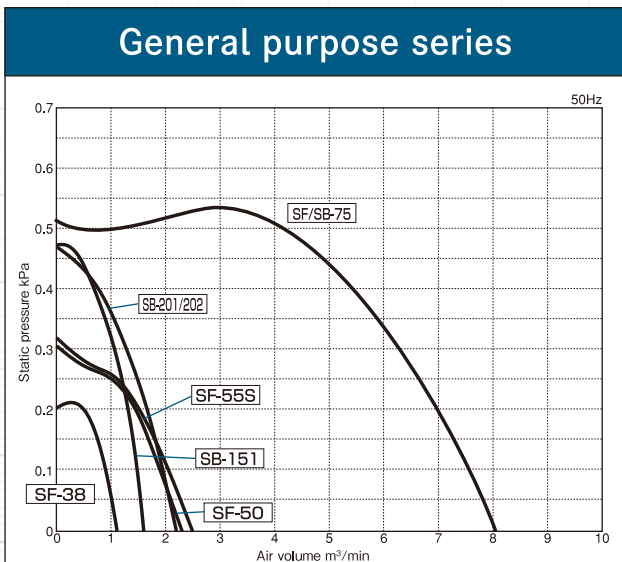
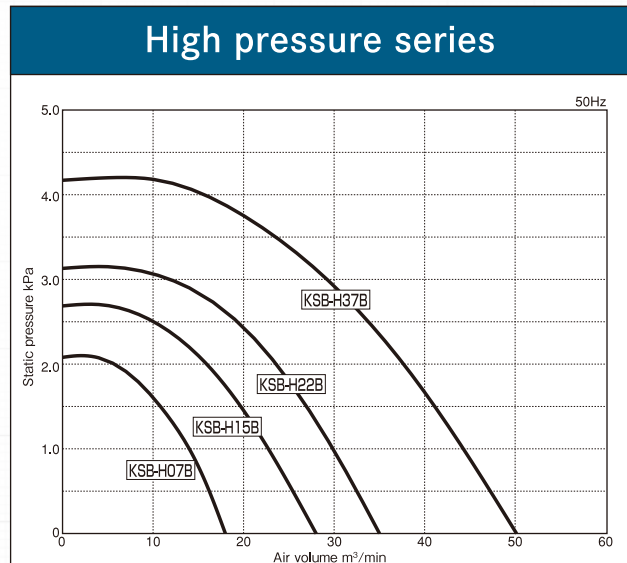
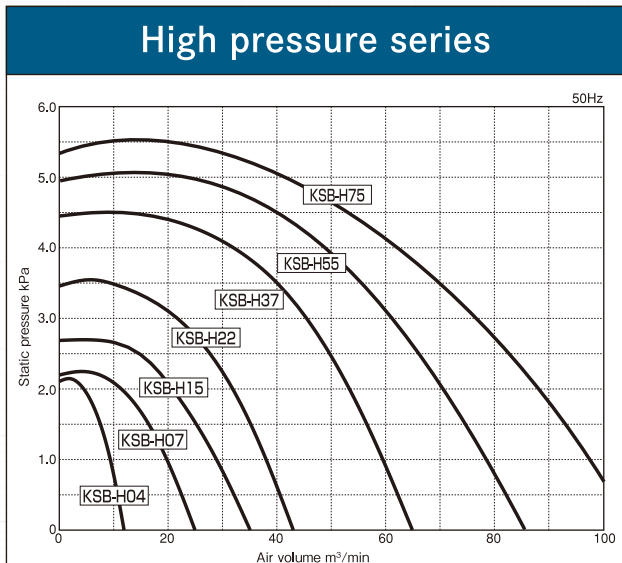
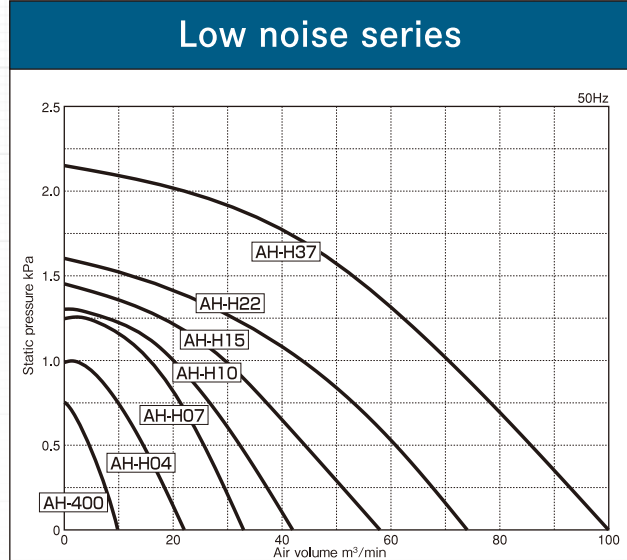
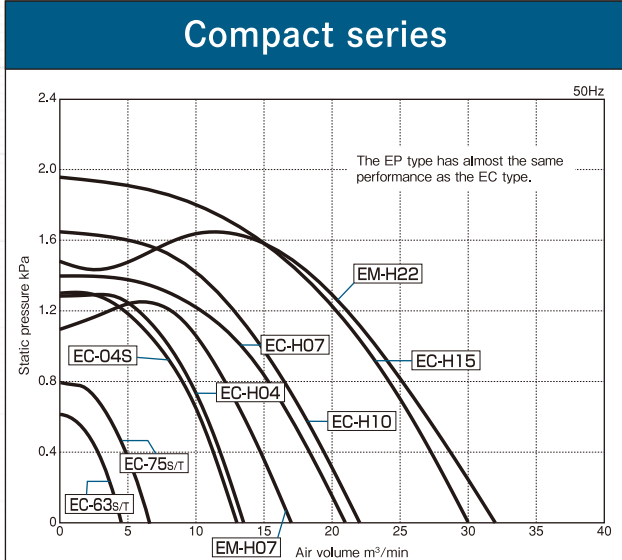



## For 50Hz

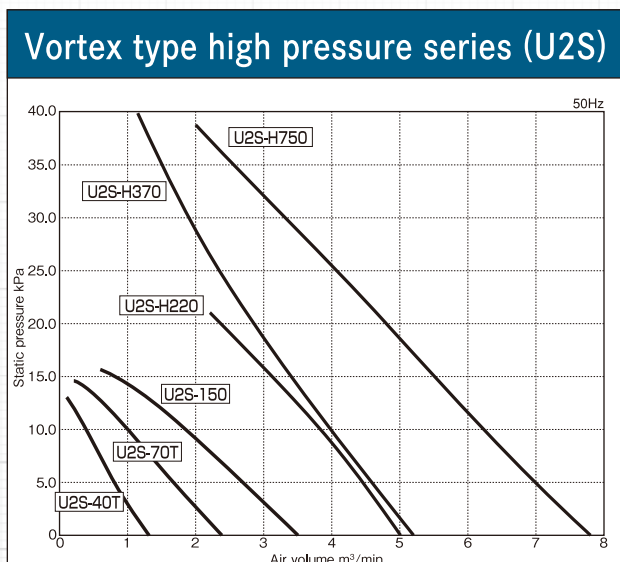
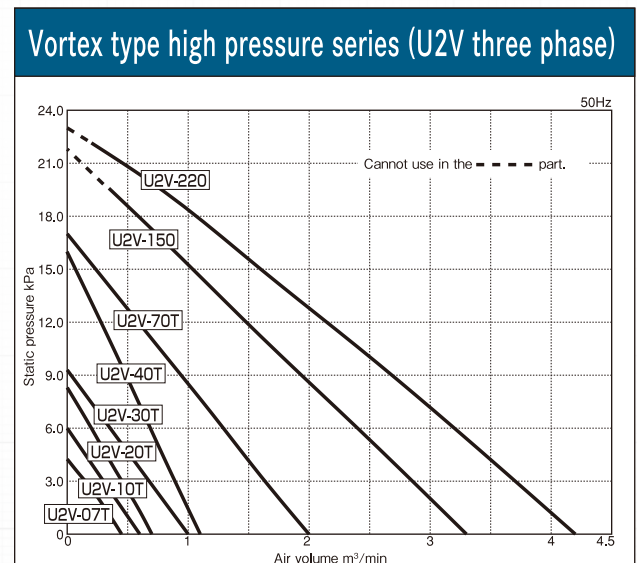
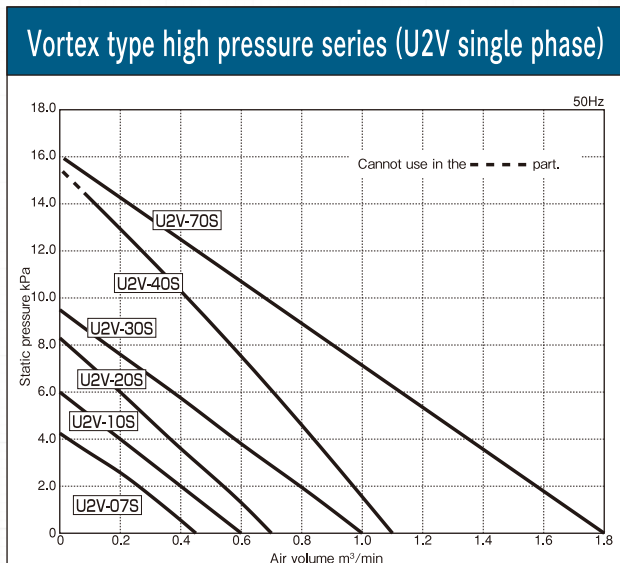
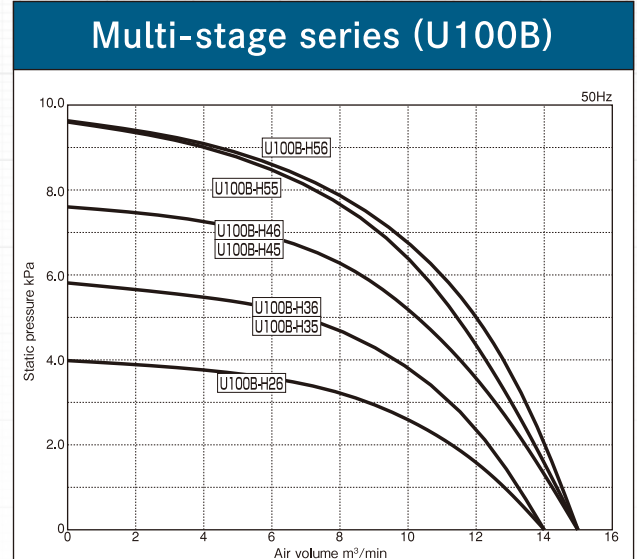
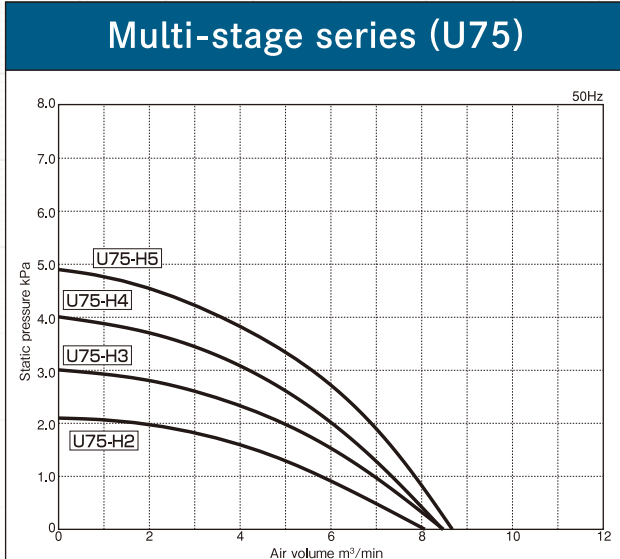

# Electric blower · Performance curves

The performance curves are displayed based on the blower series. Page 10 and 11 are for 60Hz. Please use when selecting a model.

## For 60Hz

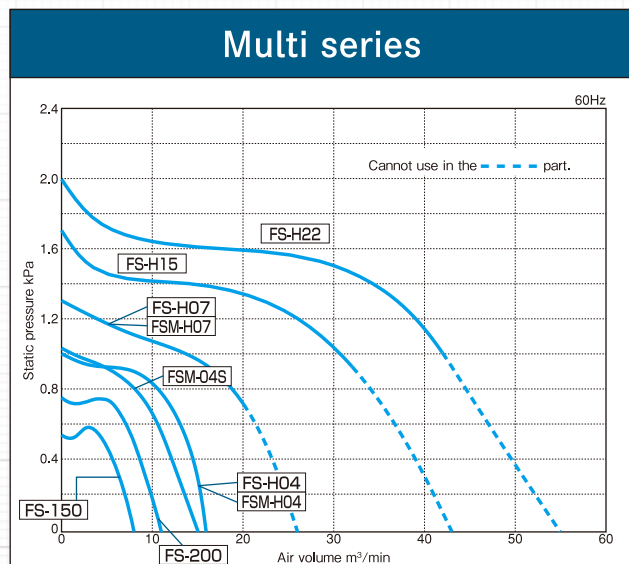
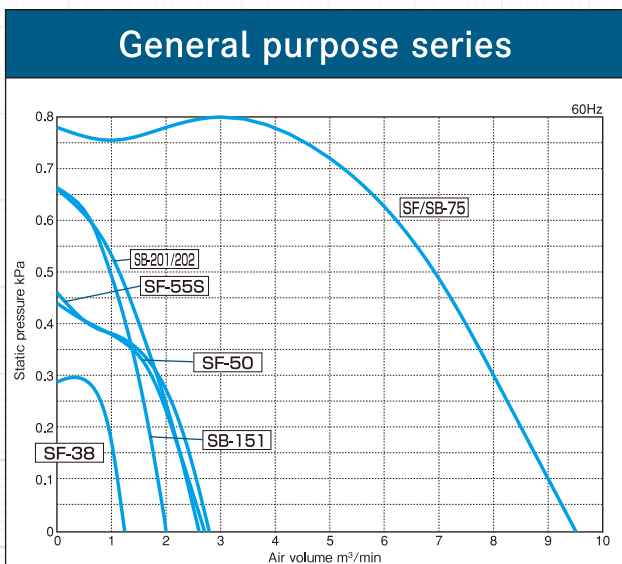
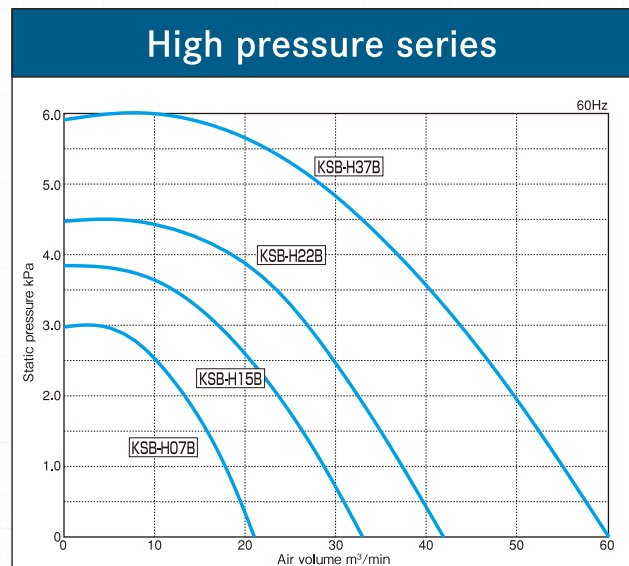
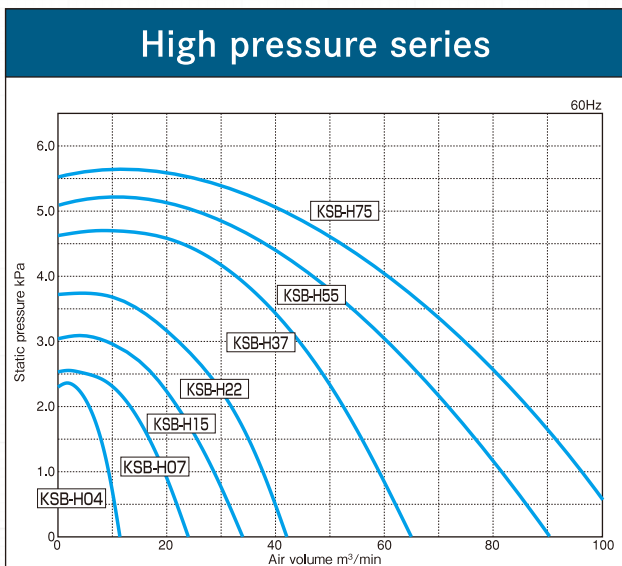
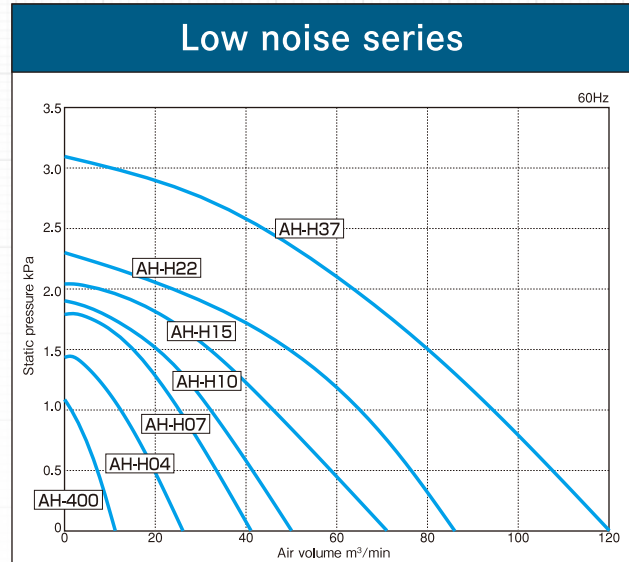
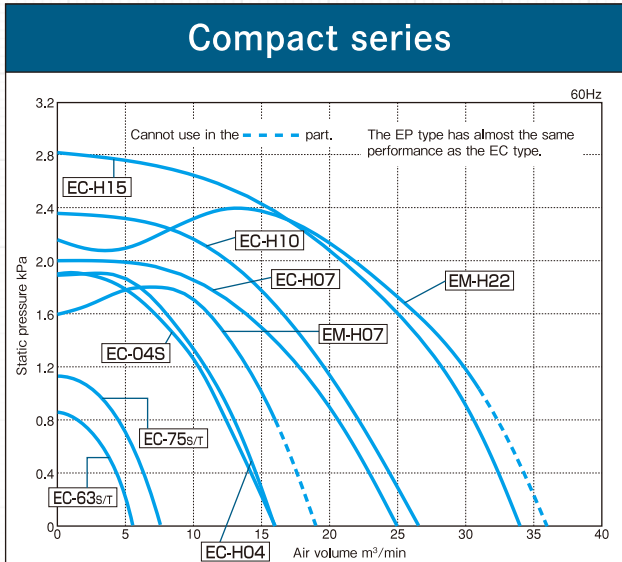

## For 60Hz

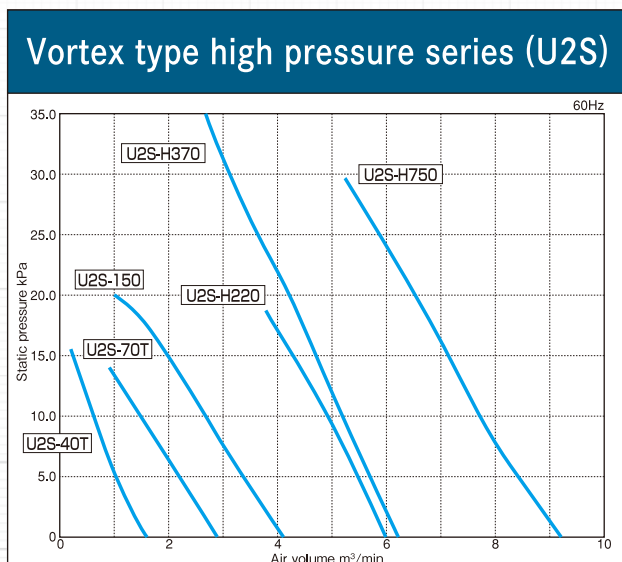
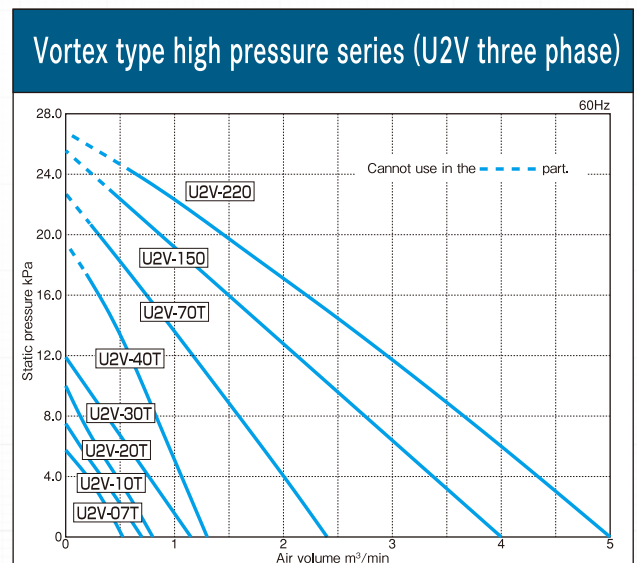
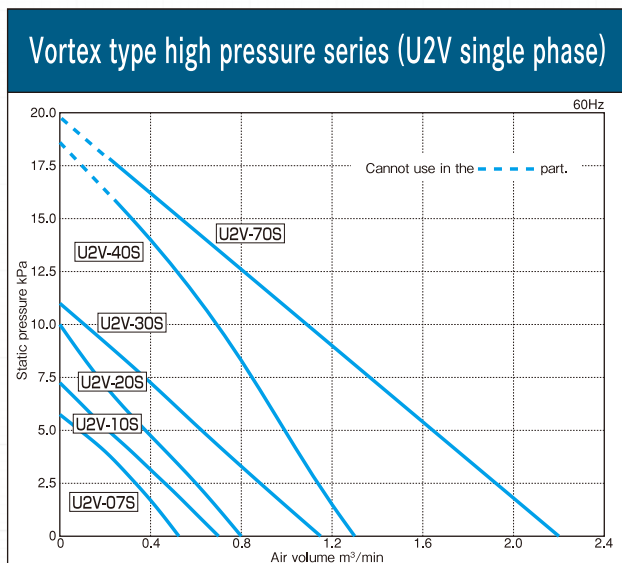
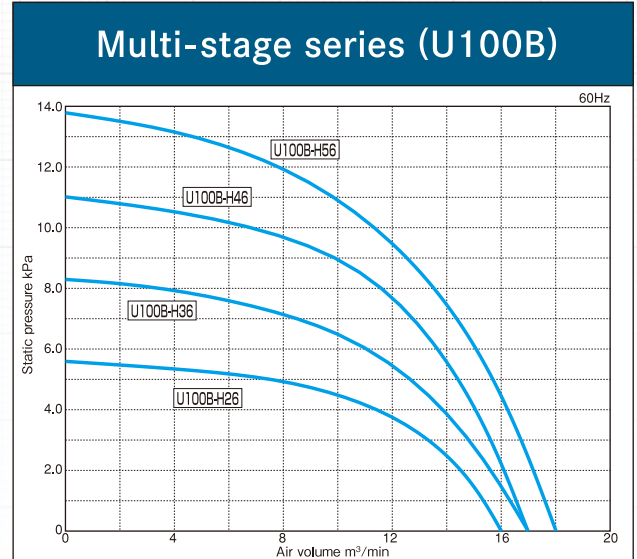
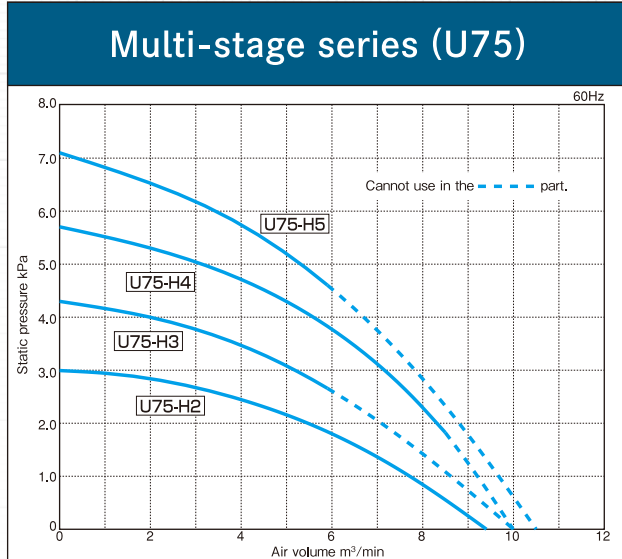



# Electric blowers

## High-efficiency electric blowers equipped with premium efficiency motor (IE3)

For high-efficiency electric blowers equipped with overseas standards (UL/CE) certified motors, please consult our company's representative.

## Efficiency standard value (IE code) from JIS C 4034-30

Motor efficiency standard value defined based on class classifications in IEC60034-30.

IE1: Standard efficiency; IE2: High efficiency; IE3: Premium efficiency

Motors with outputs of less than 0.2kW are IE1, those with outputs of 0.4 kW are IE2, and those with outputs of 0.75kW or more are IE3.

### Compact series (E type)

#### Compact type for various applications

Compact type suitable for various applications and designed to be easily attached to industrial machinery or equipment.



EC: Right rotation  
EP: Left rotation  
EM: Right rotation

Impeller type	Model	Port dimensions		Phase	Output (kW)	50Hz		60Hz		Maximum intake air temperature (°C)		Weight (kg)
		Outlet (mm)	Intake (mm)			Maximum air volume (m <sup>3</sup> /min)	Maximum static pressure (kPa)	Maximum air volume (m <sup>3</sup> /min)	Maximum static pressure (kPa)	Standard type	Heat-resistant type	
Turbo	EC-63S	φ63	φ97	Single	0.1	4.5	0.60	5.5	0.85	60	250	6.5
	EC-63T	φ63	φ97	3	0.1	4.5	0.60	5.5	0.85	60	250	6.5
	EC-75S	φ75	φ97	Single	0.2	6.5	0.80	7.5	1.15	60	250	9
	EC-75T	φ75	φ97	3	0.2	6.5	0.80	7.5	1.15	60	250	9
	EC-04S	φ97	φ123	Single	0.4	13	1.32	16	1.91	60	250	13.8
	EC-H04	φ97	φ123	3	0.4	13.5	1.30	16	1.90	60	250	17
	EC-H07	φ123	φ148	3	0.75	21	1.40	25	2.00	60	250	25
	EC-H10	φ123	φ148	3	1.0	22	1.65	26.5	2.35	60	250	26
Plate	EP-63S	φ63	φ97	Single	0.1	5.0	0.60	6.0	0.85	60	250	6.5
	EP-63T	φ63	φ97	3	0.1	5.0	0.60	6.0	0.85	60	250	6.5
	EP-75S	φ75	φ97	Single	0.2	7.0	0.80	8.0	1.15	60	250	9
	EP-75T	φ75	φ97	3	0.2	7.0	0.80	8.0	1.15	60	250	9
	EP-04S	φ97	φ123	Single	0.4	13.5	1.18	16	1.67	60	250	13.8
	EP-H04	φ97	φ123	3	0.4	12.5	1.15	15	1.65	60	250	17
	EP-H07	φ123	φ148	3	0.75	22	1.20	19.5(26)	1.75	60	250	25
	EP-H10	φ123	φ148	3	1.0	22.5	1.45	24(26)	2.10	60	250	25
Sirocco	EM-H07	φ97	φ123	3	0.75	17	1.25	16(19)	1.80	60	250	19
	EM-H22	φ123	φ148	3	2.2	32	1.65	31(36)	2.40	60	250	38

Values in parentheses indicate maximum flow volume above rated value.

### Low-noise series (AH type)

#### Type with low drive noise and large flow volume



Left rotation

Impeller type	Model	Port dimensions		Phase	Output (kW)	50Hz		60Hz		Maximum intake air temperature (°C)		Weight (kg)
		Outlet (mm)	Intake (mm)			Maximum air volume (m <sup>3</sup> /min)	Maximum static pressure (kPa)	Maximum air volume (m <sup>3</sup> /min)	Maximum static pressure (kPa)	Standard type	Heat-resistant type	
Airfoil	AH-400	φ97	φ123	3	0.2	9.5	0.75	11	1.05	40	200	10
	AH-H04	φ123	φ148	3	0.4	22	1.00	26	1.45	40	200	20
	AH-H07	*□144×144	* 170	3	0.75	33	1.25	41	1.80	40	250	30
	AH-H10	*□160×160	* 200	3	1.0	42	1.30	50	1.90	40	250	36
	AH-H15	*□180×180	* 250	3	1.5	58	1.45	71	2.05	60	250	52
	AH-H22	*□210×210	* 275	3	2.2	74	1.60	86	2.30	60	250	61
	AH-H37	*□240×240	* 300	3	3.7	100	2.15	120	3.10	60	250	77

\*mark indicates inner dimensions of outlet flange or intake flange.

### High-pressure series (KSB type)

#### Type with high efficiency and wide selection range



Right rotation

Impeller type	Model	Port dimensions		Phase	Output (kW)	50Hz		60Hz		Maximum intake air temperature (°C)		Weight (kg)
		Outlet (mm)	Intake (mm)			Maximum air volume (m <sup>3</sup> /min)	Maximum static pressure (kPa)	Maximum air volume (m <sup>3</sup> /min)	Maximum static pressure (kPa)	Standard type	Heat-resistant type	
Turbo	KSB-H04	φ82	φ123	3	0.4	12	2.15	11.5	2.35	60	250	24
	KSB-H07	φ123	φ175	3	0.75	25	2.25	24	2.55	60	250	29
	KSB-H15	φ123	φ175	3	1.5	35	2.70	34	3.10	60	250	45
	KSB-H22	φ148	φ175	3	2.2	43	3.55	42	3.75	60	250	53
	KSB-H37	φ175	φ200	3	3.7	65	4.50	65	4.70	60	250	70
	KSB-H55	JIS 5K 200A	JIS 5K 200A	3	5.5	85	5.08	90	5.16	80	250	146
	KSB-H75	JIS 5K 200A	JIS 5K 250A	3	7.5	105	5.53	105	5.68	80	250	156
	KSB-H07B	φ123	φ175	3	0.75	18	2.10	21	3.00	60	250	29
	KSB-H15B	φ123	φ175	3	1.5	28	2.70	33	3.85	60	250	45
	KSB-H22B	φ148	φ175	3	2.2	35	3.15	42	4.50	60	250	52
	KSB-H37B	φ175	φ200	3	3.7	50	4.20	60	6.00	60	250	69

### General-purpose series (SF, SB types)

#### General-purpose type that can meet any need

General-purpose type with lineup from 0.025kW to 0.25kW

SF-38, SF-50.

SF-55S: Left rotation

SB-151, SB-201.

SB-202, SF-75, SB-75: Right rotation



Impeller type	Model	Port dimensions		Phase	Output (kW)	50Hz		60Hz		Maximum intake air temperature (°C)		Weight (kg)
		Outlet (mm)	Intake (mm)			Maximum air volume (m <sup>3</sup> /min)	Maximum static pressure (kPa)	Maximum air volume (m <sup>3</sup> /min)	Maximum static pressure (kPa)	Standard type	Heat-resistant type	
Sirocco	SF-38	φ41	Slide damper	Single	0.025	1.1	0.23	1.3	0.33	40	180	2
	SF-50	φ49	Slide damper	Single	0.04	2.3	0.31	2.7	0.44	40	180	2.9
	SF-55S	φ49	Slide damper	Single	0.04	2.5	0.32	2.8	0.46	40	180	3
Turbo	SB-151	φ41	Slide damper	Single	0.04	1.6	0.47	2.0	0.66	40	—	3
	SB-201	φ49	※φ63	Single	0.04	2.2	0.47	2.6	0.66	40	200	3
	SB-202	φ49	※φ63	3	0.04	2.2	0.47	2.6	0.66	40	200	3
Sirocco	SF-75	φ75	※φ123	Single	0.25	8.0	0.55	9.5	0.80	40	200	8
	SB-75	φ75	※φ123	3	0.25	8.0	0.55	9.5	0.80	40	200	8

( ) Numbers in parentheses are the performance for heat-resistant types

# Electric blowers

## Multi series (FS, FSM types)

FS type with direct mounting of outlet flange  
FSM type which is easily combined into a set  
with industrial machinery

Compact design  
type that  
employs  
sirocco  
impeller.

Right rotation

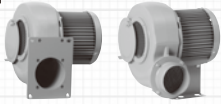

Impeller type	Model	Port dimensions		Phase	Output (kW)	50Hz		60Hz		Maximum intake air temperature (°C)		Weight (kg)
		Outlet (mm)	Intake (mm)			Maximum air volume (m³/min)	Maximum static pressure (kPa)	Maximum air volume (m³/min)	Maximum static pressure (kPa)	Standard type	Heat-resistant type	
Sirocco	FS-150	70×80	※97	3	0.2	7.0(6.2)	0.39(0.35)	8.0(7.0)	0.55(0.50)	40	200	6.0
	FS-200	76×76	※123	3	0.25	9.5	0.55	11	0.75	40	200	8.5
	FS-H04	φ106	※123	3	0.4	15	0.70	16	1.00	60	250	16
	FS-H07	φ125	※148	3	0.75	23	0.90	20(26)	1.30	60	250	20
	FS-H15	134×166	※148	3	1.5	37	1.20	32(43)	1.70	60	250	36
	FS-H22	140×170	※173	3	2.2	48	1.40	42(55)	2.00	60	250	41
	FSM-04S	φ100	※123	Single	0.4	13	0.71	15	1.03	40	250	13
	FSM-H04	φ100	※123	3	0.4	15	0.70	16	1.00	60	250	16
	FSM-H07	φ123	※148	3	0.75	23	0.90	20(26)	1.30	60	250	21

Outer dimension of duct flange of heat-resistant type

Values in parentheses indicate maximum flow volume above rated value.

( ) Numbers in parentheses are the performance for heat-resistant types.

## Multi-stage type (U type)

Type with multi-stage design for small flow volume and high pressure

Right rotation



Impeller type	Model	Port dimensions		Phase	Output (kW)	50Hz		60Hz		Maximum intake air temperature (°C)		Weight (kg)
		Outlet (mm)	Intake (mm)			Maximum air volume (m³/min)	Maximum static pressure (kPa)	Maximum air volume (m³/min)	Maximum static pressure (kPa)	Standard type	Heat-resistant type	
Turbo	U75-H2	φ75	φ123	3	0.4	8.1	2.10	9.4	3.00	60	150	16
	U75-H3	φ75	φ123	3	0.4	8.5	3.00	5.9(10)	4.30	60	150	18
	U75-H4	φ75	φ123	3	1.0	8.5	4.00	8.5(10)	5.70	60	▲ 70	25
	U75-H5	φ75	φ123	3	1.0	8.7	4.90	5.9(10.5)	7.10	60	▲ 70	27
	U100B-H26	φ100	φ148	3	1.5	14	4.00	16	5.60	40	▲ 150	39
	U100B-H35	φ100	φ148	3	1.5	14	5.80	-	-	40	▲ 70	42
	U100B-H36	φ100	φ148	3	2.2	14	5.80	17	8.30	40	▲ 70	44
	U100B-H45	φ100	φ148	3	2.2	15	7.60	-	-	40	▲ 70	47
	U100B-H46	φ100	φ148	3	3.7	15	7.60	17	11.0	40	▲ 70	52
	U100B-H55	φ100	φ148	3	2.2	15	9.60	-	-	40	▲ 70	49
	U100B-H56	φ100	φ148	3	3.7	15	9.60	18	13.8	40	▲ 70	55

For heat-resistant type maximum intake temperatures with ▲ mark, products with a maximum intake temperature of 150°C can be made by special order  
Values in parentheses indicate maximum flow volume above rated value.

## Explosion-proof series (MD, ME types)

Types which can be used in places where  
volatile gases are generated or accumulate

Types which can be used in places where volatile  
gases are generated or accumulated, with both  
series equipped with our company's explosion-  
proof motors.

MD type: Pressure-resistant explosion-proof type  
ME type: Increased-safety explosion-proof type

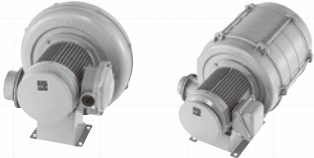

Impeller type	Model	Port dimensions		Phase	Output (kW)	50Hz		60Hz		Maximum intake air temperature (°C)		Weight (kg)
		Outlet (mm)	Intake (mm)			Maximum air volume (m³/min)	Maximum static pressure (kPa)	Maximum air volume (m³/min)	Maximum static pressure (kPa)	Standard type	Heat-resistant type	
Turbo	MD/ME/MDF-EC-63T	φ63	φ97	3	0.2	4.5	0.60	5.5	0.85	40	120/150	10/8
	MD/ME/MDF-EC-75T	φ75	φ97	3	0.2	6.5	0.80	7.5	1.15	40	120/150	11/9
	MD/ME/MDF-EC-100T	φ97	φ123	3	0.5	13	1.30	16	1.90	40	120/150	16/15
	MD/ME/MDF-EC-07	φ123	φ148	3	0.75	21	1.40	19	2.00	40	120/150	35/34
	MD/ME/MDF-EC-125	φ123	φ148	3	1.0	24	1.70	25(28)	2.50	40	120/150	25/23
	MD/ME/MDF-EC-15	φ148	φ148	3	1.5	30	1.95	34	2.80	40	120/150	35/33
Sirocco	MD/ME/MDF-EM-100T7	φ97	φ123	3	0.75	16	1.25	16(19)	1.80	40	120/150	20/18
	MD/ME/MDF-EM-125M2	φ123	φ148	3	2.2	33	1.65	32(37)	2.50	40	120/150	31/28
Plate	MD/ME/MDF-EP-63T	φ63	φ97	3	0.2	5.0	0.60	6.0	0.85	40	120/150	10/8
	MD/ME/MDF-EP-75T	φ75	φ97	3	0.2	7.0	0.80	8.0	1.15	40	120/150	11/9
	MD/ME/MDF-EP-100T	φ97	φ123	3	0.5	13.5	1.20	14(16)	1.70	40	120/150	16/14
	MD/ME/MDF-EP-07	φ123	φ148	3	0.75	22	1.20	20	1.75	40	120/150	35/34
	MD/ME/MDF-EP-125	φ123	φ148	3	1.0	23	1.50	22(27)	2.15	40	120/150	24/22
	MD/ME/MDF-EP-15	φ148	φ148	3	1.5	30	1.65	34	2.35	40	120/150	35/33
Airfoil	MD/ME/MDF-AH-400	φ97	φ123	3	0.2	9.5	0.75	11	1.05	40	120/150	35/34
	MD/ME/MDF-AH-500	φ123	φ148	3	0.5	18	1.00	21	1.40	40	120/150	13/11
	MD/ME/MDF-AH-600	*144×144	*170	3	0.75	32	1.25	38	1.80	40	120/150	20/18
	MD/ME/MDF-AH-800	*160×160	*200	3	1.0	40	1.30	47	1.90	40	120/150	30/28
	MD/ME/MDF-AH-1000	*180×180	*250	3	1.5	56	1.45	67	2.00	40	120/150	34/32
	MD/ME/MDF-AH-1200	*210×210	*275	3	2.2	76	1.60	90	2.35	40	120/150	47/44
	MD/ME/MDF-AH-H37	*240×240	*300	3	3.7	100	2.15	120	3.10	40	120/150	80/77
Turbo	MD/ME/MDF-KSB-400	φ82	φ123	3	0.5	11	2.05	11.5	2.25	40	120/150	25/23
	MD/ME/MDF-KSB-750	φ123	φ175	3	0.75	20(24)	2.20	22.5	2.45	40	120/150	31/29
	MD/ME/MDF-KSB-1500	φ123	φ175	3	1.5	33	2.65	33	3.05	40	120/150	40/38
	MD/ME/MDF-KSB-2200	φ148	φ175	3	2.2	40	3.45	40	3.70	40	120/150	44/42
	MD/ME/MDF-KSB-H37	φ175	φ200	3	3.7	65	4.50	65	4.70	40	120/150	73/70
	MD/ME/MDF-KSB-750B	φ123	φ175	3	0.75	17	2.05	20	2.90	40	120/150	30/29
	MD/ME/MDF-KSB-1500B	φ123	φ175	3	1.5	26	2.60	30	3.80	40	120/150	40/38
	MD/ME/MDF-KSB-2200B	φ148	φ175	3	2.2	32	3.10	34(38)	4.40	40	120/150	44/42
	MD/ME/MDF-KSB-H37B	φ175	φ200	3	3.7	50	4.20	60	6.00	40	120/150	72/69
		MD/ME/MDF-SB-75	φ75	slide damper <sup>※1</sup> (148)	3	0.75	21	0.90	20(25)	1.30	40	120/150
Sirocco	MD/ME/MDF-FSM-04	φ100	slide damper <sup>※1</sup> (123)	3	0.5	15	0.70	14	1.00	40	120/150	15/13
	MD/ME/MDF-FSM-07	φ123	slide damper <sup>※1</sup> (148)	3	0.75	23	0.85	19	1.25	40	120/150	20/18
Sirocco	MD/ME/MDF-FS-150	*70×80	slide damper <sup>※1</sup> (97)	3	0.2	7.0	0.39	8.0	0.55	40	120/150	9/7
	MD/ME/MDF-FS-200	*76×76	slide damper <sup>※1</sup> (123)	3	0.25	9.5	0.55	8.0(11)	0.75	40	120/150	13/11
	MD/ME/MDF-FS-04	φ106	slide damper <sup>※1</sup> (123)	3	0.5	15	0.70	14	1.00	40	120/150	15/13
	MD/ME/MDF-FS-07	φ125	slide damper <sup>※1</sup> (148)	3	0.75	23	0.85	19	1.25	40	120/150	20/18
	MD/ME/MDF-FS-1500	*144×166	slide damper <sup>※1</sup> (148)	3	1.5	32	1.10	35(39)	1.60	40	120/150	30/28
	MD/ME/MDF-FS-2200	*150×170	slide damper <sup>※1</sup> (173)	3	2.2	45	1.40	43(53)	2.05	40	120/150	32/30
Turbo	MD/ME/MDF-U75-2	φ75	φ123	3	0.5	8.0	2.05	9.2	2.95	40	120/150	17/15
	MD/ME/MDF-U75-3	φ75	φ123	3	0.5	8.3	2.95	4.8(9.5)	4.20	40	120/150	19/17
	MD/ME/MDF-U75-4	φ75	φ123	3	1.0	8.5	3.90	9.0(10)	5.50	40	70	24/22
	MD/ME/MDF-U75-5	φ75	φ123	3	1.0	8.8	4.80	5.8(10)	6.80	40	70	26/24
	MD/ME/MDF-U100B-26	φ100	φ148	3	1.5	14	3.90	16	5.60	40	120/150	36/34
	MD/ME-MDF-U100B-35	φ100	φ148	3	1.5	13	5.70	-	-	40	70	42/40
	MD/ME/MDF-U100B-36	φ100	φ148	3	2.2	14	5.80	17	8.30	40	70	42/40
	MD/ME-U100B-45	φ100	φ148	3	2.2	14	7.60	-	-	40	70	48/45
	MD/ME/MDF-U100B-H46	φ100	φ148	3	3.7	15	7.60	17	11.0	40	70	55/52
	MD/ME/MDF-U100B-55	φ100	φ148	3	2.2	14	9.50	-	-	40	70	53/50
	MD/ME/MDF-U100B-H56	φ100	φ148	3	3.7	15	9.60	18	13.80	40	70	58/55

Approximate weight for MDF is excluding inverter.

Values in parentheses indicate maximum flow volume above rated value.

\*1 : Values in parentheses are outer diameters of duct flange of heat-resistant type

\*2 : In the case of MDF-KSB type, the performance at 50Hz is different from the displayed performance.

# Electric blowers

## Vortex-type high-pressure series Gust blower (U2V type)

### Low-drive-noise type with built-in high-performance silencer

Use of new impeller and large-size cooling fan enable operation in all regions down to closed. (Excluding some models that use outlets.)



Impeller type	Model	Phase	Output (kW)	Intake side				Outlet side				Maximum intake air temperature (°C)	Weight (kg)
				50Hz		60Hz		50Hz		60Hz			
				Maximum air volume (m³/min)	Maximum static pressure (kPa)	Maximum air volume (m³/min)	Maximum static pressure (kPa)	Maximum air volume (m³/min)	Maximum static pressure (kPa)	Maximum air volume (m³/min)	Maximum static pressure (kPa)		
Votex	U2V-07S	Single	0.07	0.45	4.00	0.52	5.40	0.45	4.20	0.52	5.60	40	6
	U2V-07T	3	0.07	0.45	4.00	0.52	5.40	0.45	4.20	0.52	5.60	40	6
	U2V-10S	Single	0.1	0.6	5.40	0.7	6.90	0.6	5.90	0.7	7.35	40	6.5
	U2V-10T	3	0.1	0.6	5.40	0.7	6.90	0.6	5.90	0.7	7.35	40	6.5
	U2V-20S	Single	0.2	0.7	7.60	0.8	9.30	0.7	8.15	0.8	9.80	40	8.5
	U2V-20T	3	0.2	0.7	7.60	0.8	9.30	0.7	8.15	0.8	9.80	40	8.5
	U2V-30S	Single	0.3	1.0	8.80	1.15	10.3	1.0	9.30	1.15	10.9	40	9
	U2V-30T	3	0.3	1.0	8.80	1.15	10.3	1.0	9.30	1.15	11.9	40	9
	U2V-40S	Single	0.4	1.1	11.8	1.3	14.2	1.1	14.2	1.3	15.7	40	17
	U2V-40T	3	0.4	1.1	12.7	1.3	16.1	1.1	15.7	1.3	17.2	40	15
	U2V-70S	Single	0.75	1.8	12.7	2.2	16.7	1.8	16.0	2.2	17.7	40	23
	U2V-70T	3	0.75	2.0	14.7	2.4	17.6	2.0	16.7	2.4	20.5	40	17
U2V-150	3	1.5	3.3	16.2	4.0	21.1	3.3	19.6	4.0	22.6	40	26	
U2V-220	3	2.2	4.2	19.6	5.0	23.5	4.2	21.6	5.0	24.5	40	35	

## Vortex-type high-pressure series Gust blower (U2S type)

### Compact, lightweight, general-purpose type with excellent heat radiation and durability

Compact, lightweight type that achieves improved heat radiation and durability by using diecast aluminum for the casing and impeller. Dust-proof, jet-flow-proof motor construction conforms to IP55.



Impeller type	Model	Phase	Output (kW)	Intake side				Outlet side				Maximum intake air temperature (°C)	Weight (kg)
				50Hz		60Hz		50Hz		60Hz			
				Maximum air volume (m³/min)	Maximum static pressure (kPa)	Maximum air volume (m³/min)	Maximum static pressure (kPa)	Maximum air volume (m³/min)	Maximum static pressure (kPa)	Maximum air volume (m³/min)	Maximum static pressure (kPa)		
Votex	U2S-40T	3	0.4/0.5	1.3	13.0	1.6	15.5	1.3	15.0	1.6	16.5	40	10
	U2S-70T	3	0.6/0.85	2.4	14.5	2.9	14.0	2.4	12.5	2.9	13.0	40	15
	U2S-150	3	1.1/1.7	3.5	16.0	4.1	20.0	3.5	18.5	4.1	22.0	40	21
	U2S-H220	3	2.5/3.0	5.0	22.5	6.0	22.0	5.0	21.0	6.0	17.5	40	38
	U2S-H370	3	4.6/5.3	5.2	31.0	6.2	36.5	5.2	42.0	6.2	37.5	40	50
	U2S-H750	3	8.6/9.9	7.8	27.5	9.2	31.0	7.8	38.5	9.2	29.5	40	90

## Series for stirring and circulation (Double volute)

### For stirring and circulation. Heat-resistant type electric blower

With blower outlets at two locations, it can perform uniform stirring and circulation inside furnaces. Ideal for improving variations in temperature within furnaces or reducing the time necessary for heating and cooling.



Impeller type	Model	Port dimensions		Phase	Output (kW)	50Hz		60Hz		Maximum intake air temperature (°C)	Weight (kg)
		Outlet (mm)	Intake (mm)			Maximum air volume (m³/min)	Maximum static pressure (kPa)	Maximum air volume (m³/min)	Maximum static pressure (kPa)		
Turbo	WE-H04	120×99×2	φ125	3	0.4	19	1.10	22.5	1.55	300	33
	WE-H07	130×99×2	φ150	3	0.75	25	1.25	29.5	1.75	300	35
	WE-H15	155×104×2	φ170	3	1.5	38.5	1.65	45	2.35	300	50
	WE-H22	170×104×2	φ170	3	2.2	45	2.00	52.5	2.85	300	56
	WE-H37	200×114×2	φ200	3	3.7	71	2.55	83.5	3.65	300	76

## Stainless-steel construction (G) / Steel plate construction (F) series (E, AH, KSB types)

### Types resistant to corrosion and abrasion

Blowers which use SUS304 (G series) or Low-carbon steel (F series) in the flow path section to provide corrosion and abrasion resistance.



E type

Output (kW) : 0.1~2.2  
Maximum air volume (m³/min) : 5.0~33  
Maximum static pressure (kPa) : 0.55~2.95



AH type

Output (kW) : 0.2~3.7  
Maximum air volume (m³/min) : 10~122  
Maximum static pressure (kPa) : 0.75~3.15

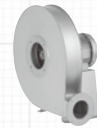

KSB type

Output (kW) : 0.4~3.7  
Maximum air volume (m³/min) : 11.5~60  
Maximum static pressure (kPa) : 2.00~5.70

※ For detailed specifications, please see our company's home page

# Usage examples



Breadmaking machine

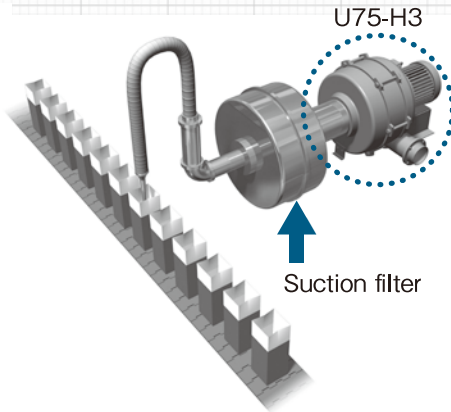

Dust collection from cartons

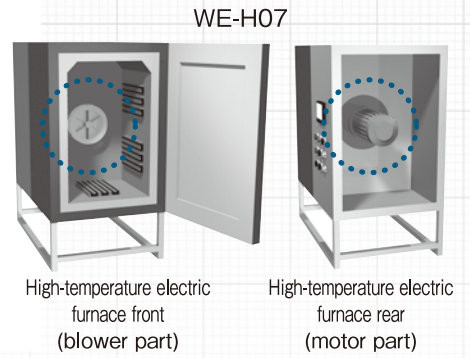

High-temperature electric furnace agitation

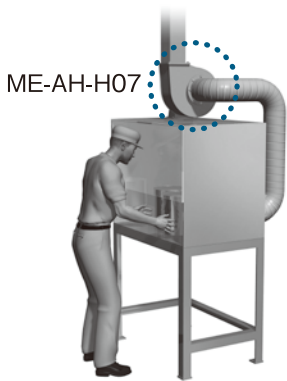

Local exhaust of organic solvents

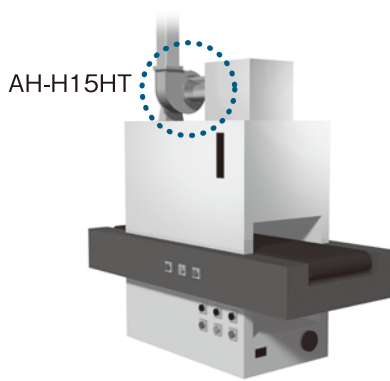

Semiconductor manufacturing equipment hot air exhaust

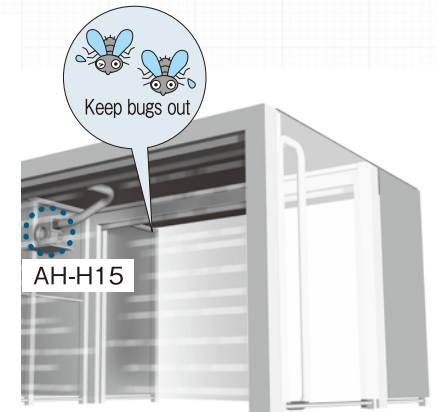

Insect-proof air curtain

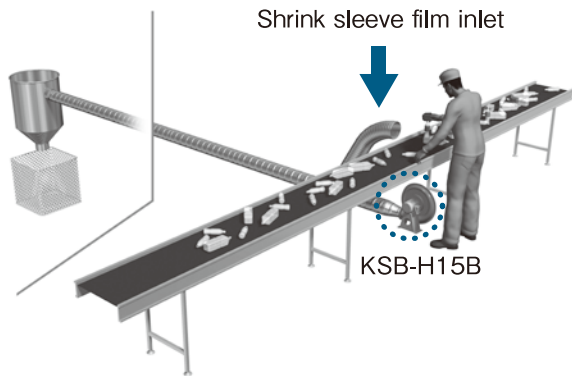

PET plastic bottle shrink film collection

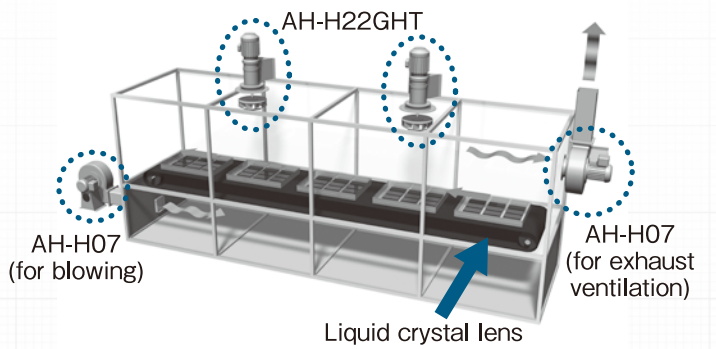

Liquid crystal lens drying

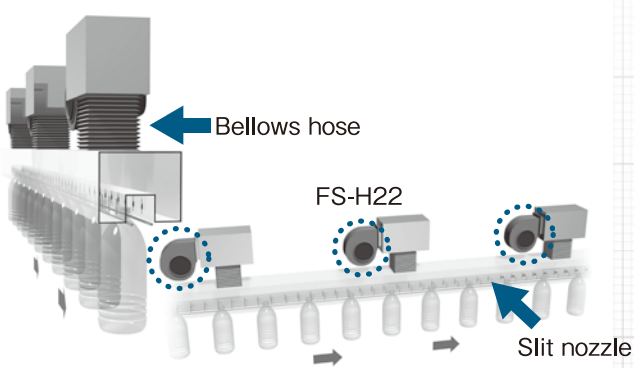

PET plastic bottle conveyor

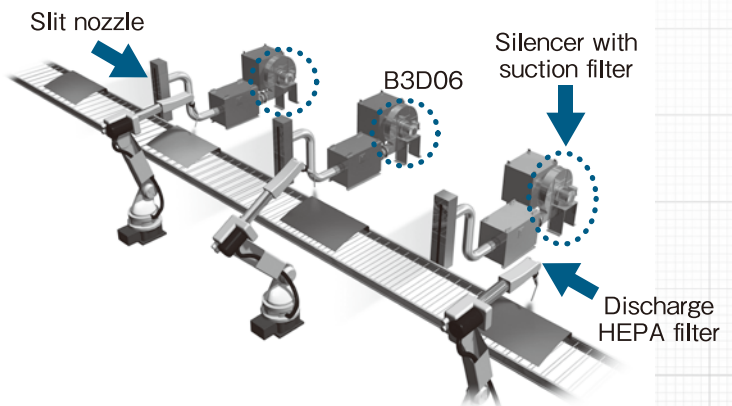

Air curtain used during spray painting



# Denchoku (Direct drive blower)

## How to read Denchoku model name

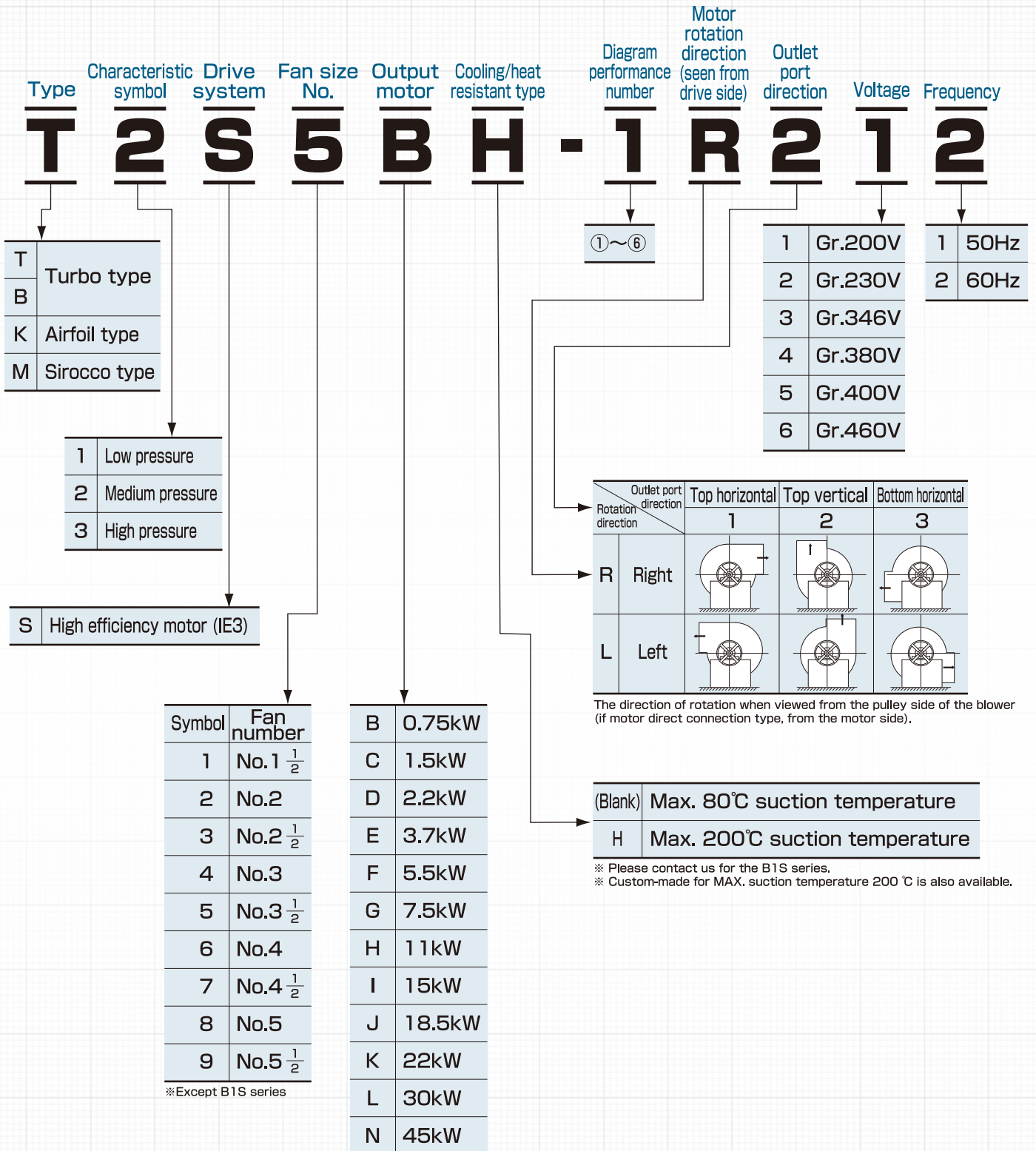

## For 50Hz

The number on the performance curve represents the performance curve numbers shown in "How to read the electric blower name" on page 17.

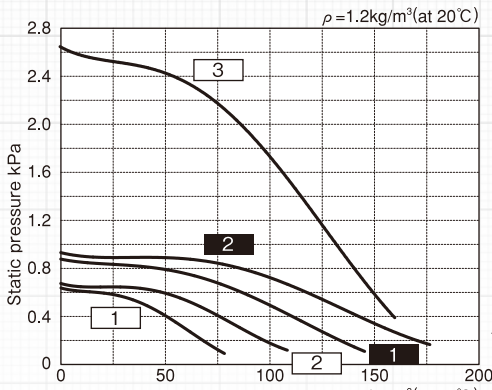

### Model K1S (Airfoil type)

K1S4  
K1S5

K1S6  
K1S7

K1S8  
K1S9

Air volume  
m³/min

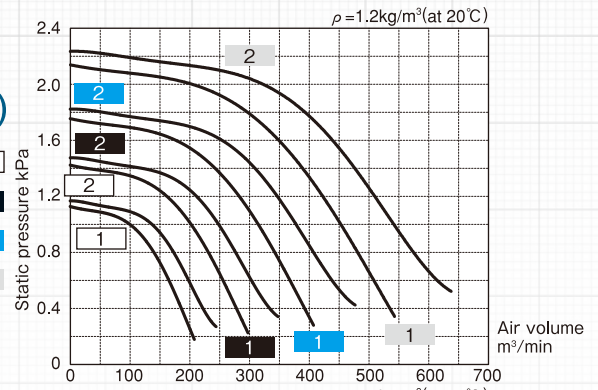

### Model M2S (Sirocco type)

M2S1  
M2S2

M2S3  
M2S4

M2S5

Air volume  
m³/min

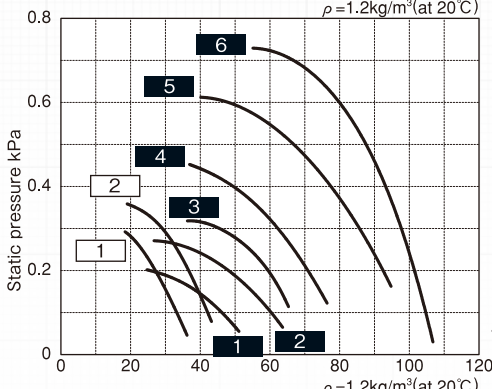

### Model T1S (Turbo type)

T1S2  
T1S3

T1S4  
T1S5

Air volume  
m³/min

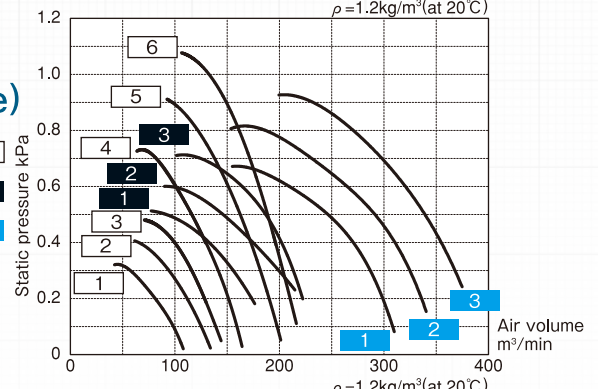

### Model T2S (Turbo type)

T2S2  
T2S3

T2S4  
T2S5

T2S6

Air volume  
m³/min

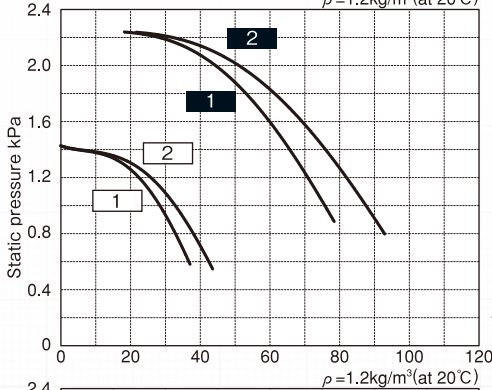

### Model B1S (Turbo type)

B1S1  
B1S2

B1S5  
B1S6

B1S3  
B1S4

B1S7

Air volume  
m³/min

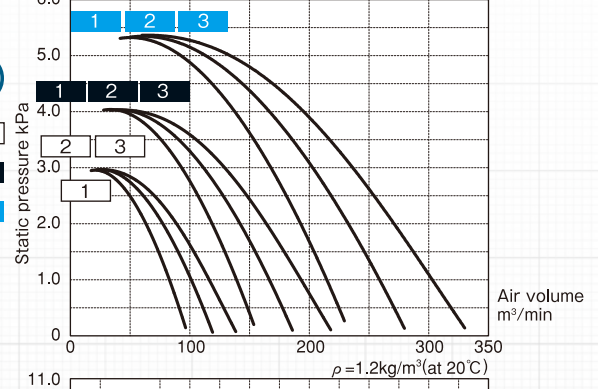
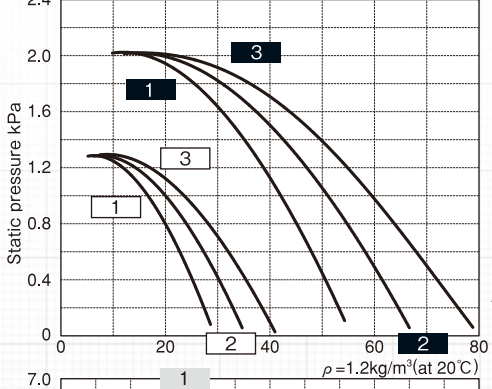
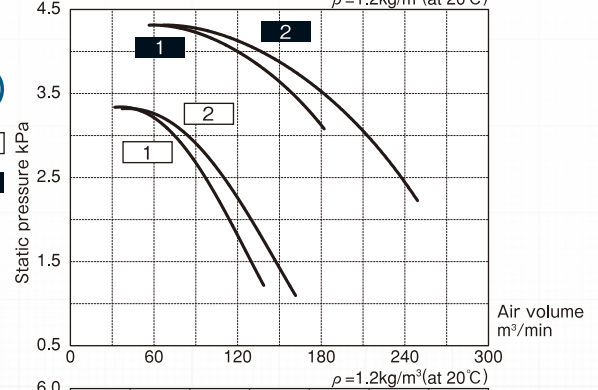

## For 60Hz

The number on the performance curve represents the performance curve numbers shown in "How to read the electric blower name" on page 17.

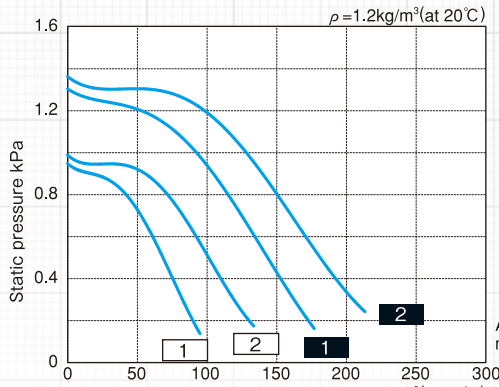

### Model K1S (Airfoil type)

K1S4

K1S6

K1S5

K1S7

K1S8

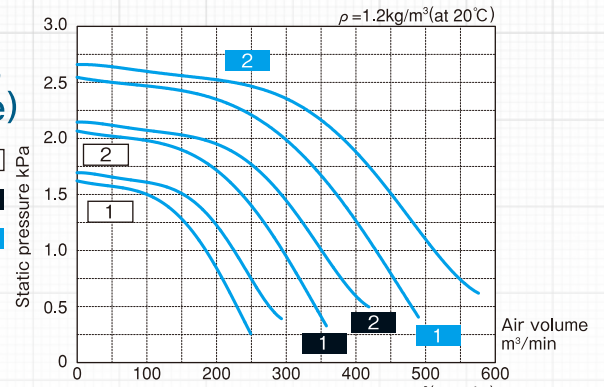

### Model M2S (Sirocco type)

M2S1

M2S3

M2S2

M2S4

M2S5

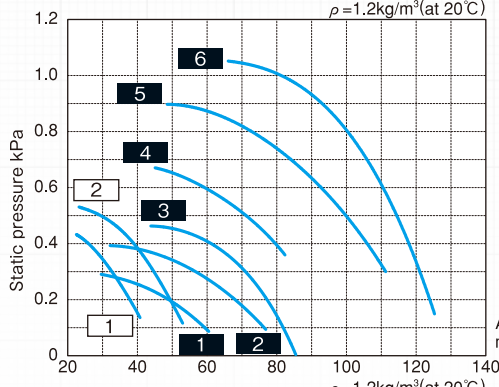

### Model T1S (Turbo type)

T1S2

T1S4

T1S3

T1S5

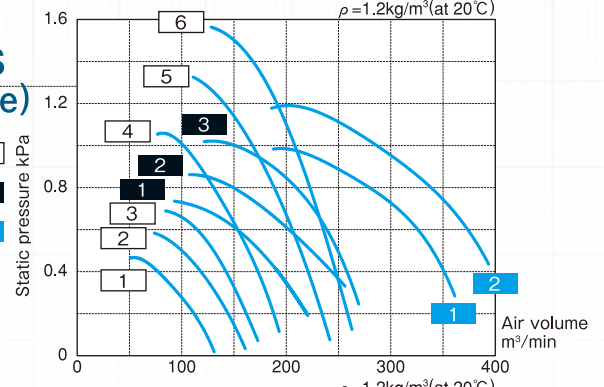

### Model T2S (Turbo type)

T2S2

T2S4

T2S3

T2S5

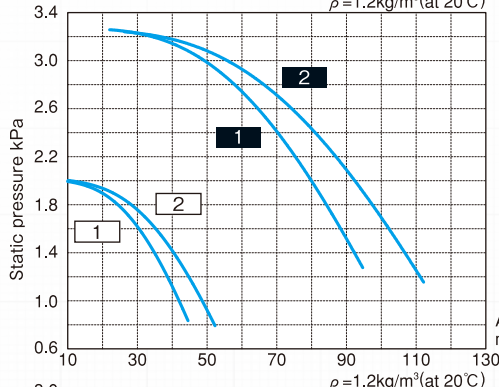

### Model B1S (Turbo type)

B1S1

B1S5

B1S2

B1S6

B1S3

B1S7

B1S4

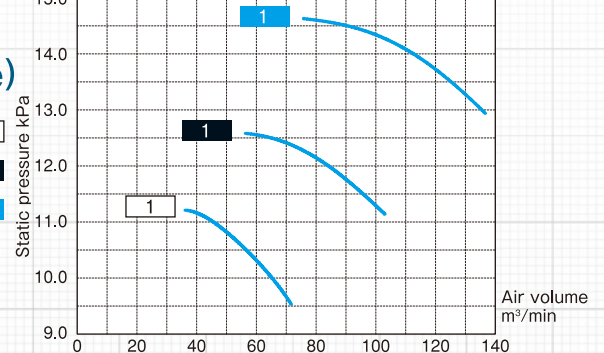
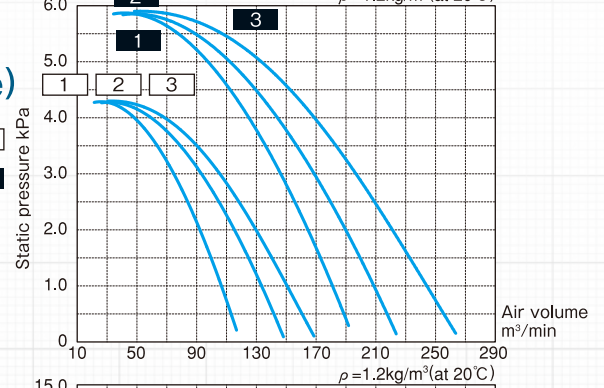



# Blower drive type

## V-belt drive

**Advantages:** Since the rotation speed of the blower can be adjusted by combining the pulleys, multiple performance curves can be set with one blower. Since the shaft of the blower can be freely designed, there is a wide design range for shaft seals or sucking high-temperature gas.

**Disadvantages:** Mechanical loss occurs because rotation is transmitted by the pulley and V-belt. The V-belt is a consumable item and needs to be replaced regularly. There are many exposed parts in the rotating and transmission systems, which poses a high risk. It is longer in the axial direction.

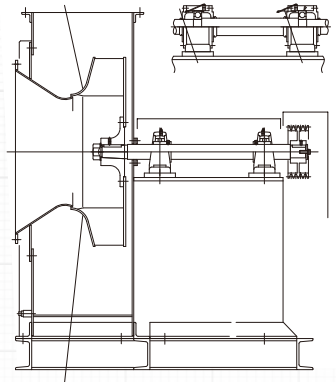

## Coupling drive

**Advantages:** High efficiency due to the direct transmission of the motor shaft rotation. Since the shaft of the blower can be freely designed, there is a wide design range for shaft seals or sucking high-temperature gas.

**Disadvantages:** Since the number of revolutions is constant according to the power frequency, to change the performance, the impeller dimensions of the impeller must be changed, or an inverter used. It is necessary to adjust the level of the blower shaft and the motor shaft. It is longer in the axial direction.

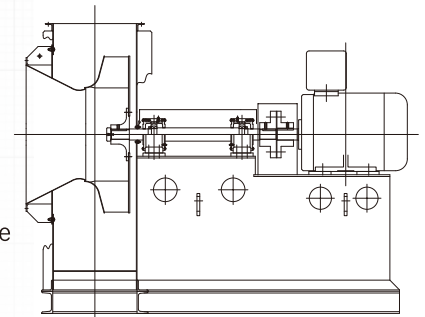

## Denchoku (Direct drive blower)

**Advantages:** Since the impeller is directly attached to the motor shaft, it is compact. It is safe because there are no exposed rotating parts. It has a high efficiency because of the direct attachment to the motor shaft.

**Disadvantages:** Since the number of revolutions is constant according to the power frequency, to change the performance, the impeller dimensions of the impeller must be changed, or an inverter used. Designs for shaft seals or sucking high-temperature gas are limited. Since the bearing is a motor bearing, the load is limited.

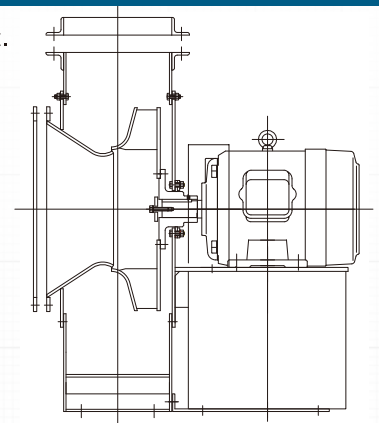

## Suction gas temperature and bearing type

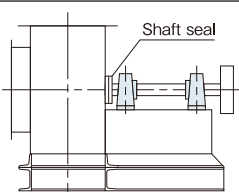
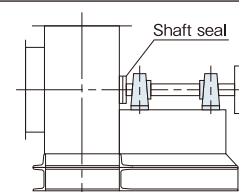
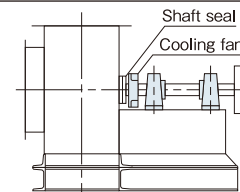
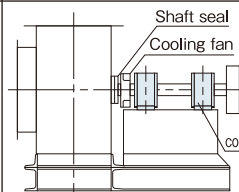
Suction gas temperature	-10°C to 50°C	50°C to 150°C	150°C to 350°C	350°C to 650°C Depending on model and revolution speed
Bearing type	Standard type	Heat-resistant type	Heat-resistant type (air-cooled)	Heat-resistant type (water-cooled)
Horizontal construction				
Lubrication	Standard grease	Heat-resistant grease	Heat-resistant grease	Heat-resistant grease
Blower coating	Standard(2.5Y 6/2)	Heat-resistant silver (under 80°C: standard)	Heat-resistant silver	Heat-resistant silver
Guard coating	Munsell 2.5YR 6/13			

# V-belt drive blower · Performance curves

## Turbo type T1

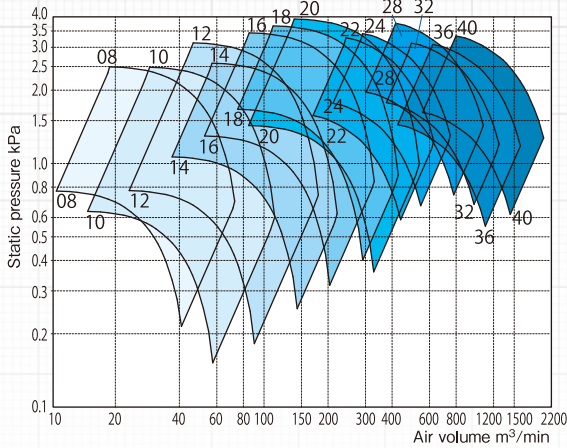

## Turbo type T2

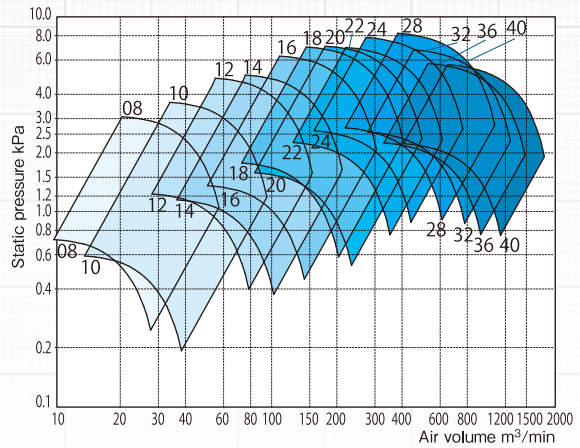

## Turbo type B2

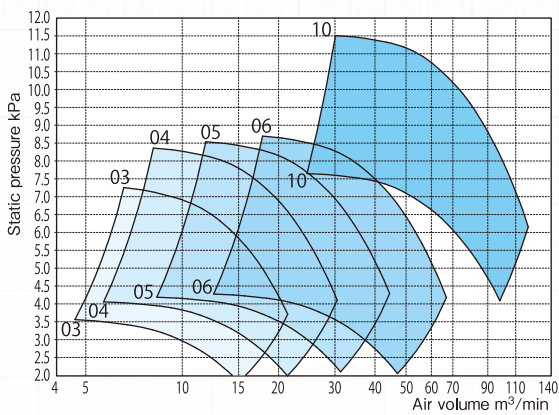

## Turbo type B3

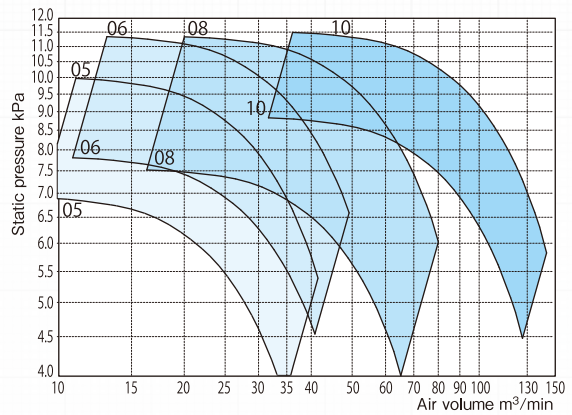

## Airfoil type S2KT

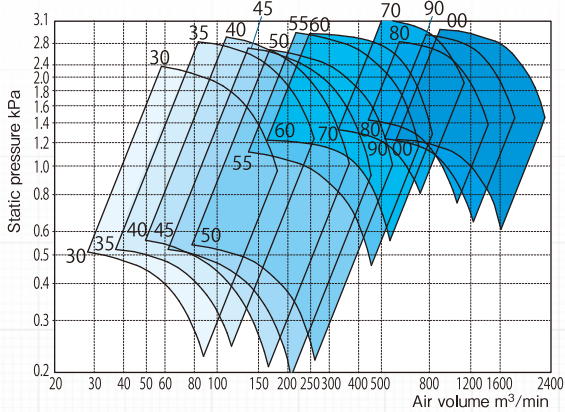

## Sirocco type M1

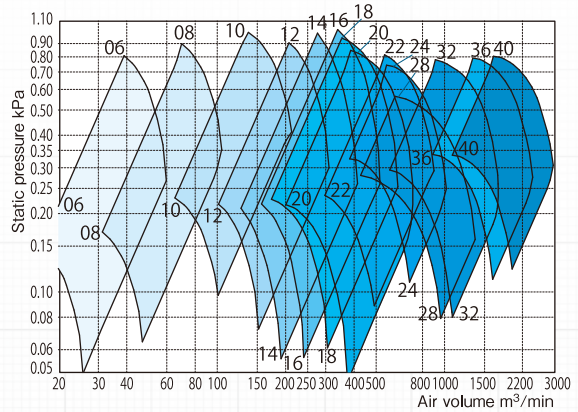

## Plate type P1

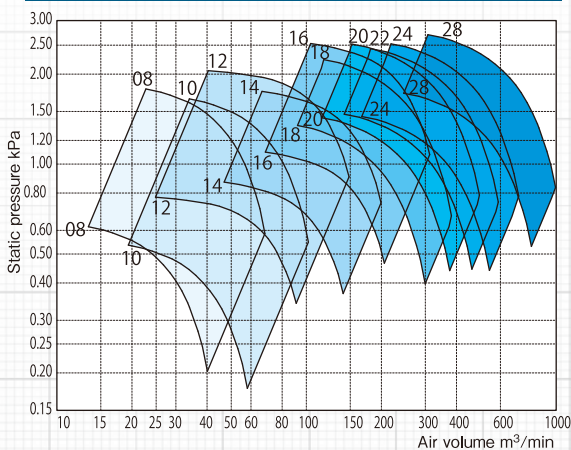

## Medium pressure plate type S2GP

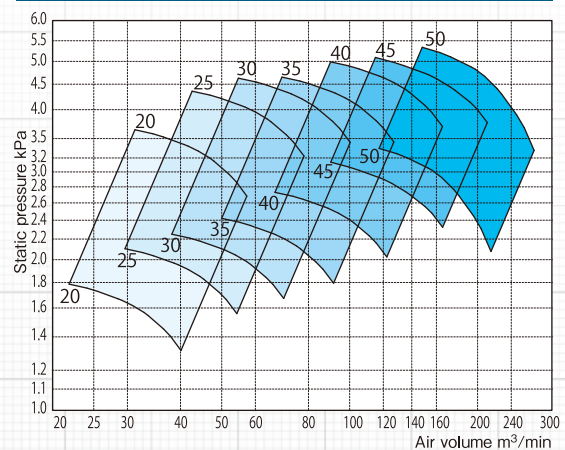

## Low-noise series A1D

## For 50Hz

Diameter Ø(mm)	Model	Performance Curve Number	Air Volume (m³/min)	MAX Static Pressure (kPa)	Motor		Noise level (dB(A))	Weight (kg)	Diameter Ø(mm)	Model	Performance Curve Number	Air Volume (m³/min)	MAX Static Pressure (kPa)	Motor		Noise level (dB(A))	Weight (kg)
					Output (kW)	Poles (P)								Output (kW)	Poles (P)		
300	A1D3A-111	①	11~14	0.05	0.4		64	35	710	A1D7C-111	①	42~96	0.37	1.5		90	155
	A1D3A-311	③	17~22	0.08	0.4		64	35		A1D7C-211	②	68~161	0.41	1.5		88	155
	A1D3A-711	⑦	25~35	0.09	0.4		67	35		A1D7C-311	③	110~225	0.41	1.5		89	155
										A1D7D-411	④	215~290	0.35	2.2	4	89	160
										A1D7E-511	⑤	272~346	0.37	3.7		88	165
										A1D7E-611	⑥	315~404	0.39	3.7		89	165
										A1D7F-711	⑦	369~453	0.43	5.5		91	185
400	A1D4A-111	①	16~33	0.13	0.4		76	50	800	A1D8C-111	①	36~83	0.24	1.5		78	190
	A1D4A-311	③	38~52	0.13	0.4		70	50		A1D8C-211	②	61~142	0.25	1.5		82	190
	A1D4A-711	⑦	68~90	0.16	0.4		74	50		A1D8C-311	③	108~203	0.24	1.5		83	190
										A1D8C-411	④	202~275	0.20	1.5		80	190
										A1D8D-511	⑤	244~325	0.21	2.2		80	195
										A1D8D-611	⑥	310~408	0.22	2.2		79	195
										A1D8E-711	⑦	338~465	0.25	3.7		83	220
500	A1D5A-111	①	30~45	0.14	0.4	4	82	65	900	A1D9E-411	④	307~409	0.27	3.7		86	300
	A1D5A-211	②	45~60	0.14	0.4		82	65		A1D9E-511	⑤	384~500	0.30	3.7		85	300
	A1D5A-311	③	65~87	0.16	0.4		78	65		A1D9F-611	⑥	445~594	0.32	5.5	6	87	300
	A1D5A-411	④	81~102	0.16	0.4		78	65		A1D9F-711	⑦	493~678	0.34	5.5		89	300
	A1D5B-511	⑤	95~123	0.17	0.75		79	70									
	A1D5B-611	⑥	100~142	0.18	0.75		79	70									
	A1D5B-711	⑦	106~154	0.20	0.75		81	70									
630	A1D6B-111	①	39~86	0.25	0.75		84	90	1000	A1D10F-511	⑤	456~595	0.32	5.5		90	340
	A1D6B-211	②	80~138	0.25	0.75		83	90		A1D10F-611	⑥	544~715	0.33	5.5		90	340
	A1D6C-311	③	121~182	0.26	1.5		82	95		A1D10G-711	⑦	630~805	0.35	7.5		91	370
	A1D6C-411	④	155~227	0.26	1.5		79	95									
	A1D6C-511	⑤	188~252	0.27	1.5		78	95									
	A1D6D-611	⑥	210~287	0.29	2.2		79	100									
	A1D6E-711	⑦	234~322	0.34	3.7		81	105									

## Low-noise series A1D

## For 60Hz

Diameter Ø(mm)	Model	Performance Curve Number	Air Volume (m³/min)	MAX Static Pressure (kPa)	Motor		Noise level (dB(A))	Weight (kg)	Diameter Ø(mm)	Model	Performance Curve Number	Air Volume (m³/min)	MAX Static Pressure (kPa)	Motor		Noise level (dB(A))	Weight (kg)
					Output (kW)	Poles (P)								Output (kW)	Poles (P)		
300	A1D3A-112	①	13~17	0.08	0.4		68	35	710	A1D7C-112	①	51~115	0.55	1.5		94	155
	A1D3A-312	③	20~24	0.11	0.4		69	35		A1D7D-212	②	83~194	0.60	2.2		92	160
	A1D3A-712	⑦	30~42	0.13	0.4		68	35		A1D7E-312	③	132~272	0.61	3.7		93	165
							67	35		A1D7E-412	④	280~350	0.48	3.7	4	93	165
							69	35		A1D7F-512	⑤	327~418	0.54	5.5		92	185
							70	35		A1D7G-612	⑥	380~487	0.57	7.5		93	190
							71	35		A1D7H-712	⑦	445~546	0.62	11		95	225
400	A1D4A-112	①	19~40	0.19	0.4		79	50	800	A1D8C-112	①	42~121	0.35	1.5		84	190
	A1D4A-312	③	43~61	0.19	0.4		76	50		A1D8C-212	②	75~190	0.36	1.5		88	190
	A1D4B-712	⑦	76~102	0.23	0.75		74	50		A1D8D-312	③	120~270	0.36	2.2		86	195
							73	50		A1D8D-412	④	240~340	0.29	2.2		84	195
							74	55		A1D8E-512	⑤	295~410	0.30	3.7		85	220
							75	55		A1D8F-612	⑥	372~500	0.32	5.5		84	225
							76	55		A1D8F-712	⑦	405~570	0.37	5.5		86	225
500	A1D5A-112	①	36~53	0.21	0.4	4	85	65	900	A1D9E-312	③	205~383	0.47	3.7		91	300
	A1D5A-212	②	52~80	0.20	0.4		82	70		A1D9F-412	④	372~493	0.40	5.5		90	300
	A1D5B-312	③	79~108	0.23	0.75		81	70		A1D9F-512	⑤	460~603	0.44	5.5	6	89	300
	A1D5B-412	④	95~124	0.23	0.75		82	70		A1D9G-612	⑥	534~716	0.47	7.5		91	330
	A1D5C-512	⑤	115~153	0.26	1.5		83	70		A1D9H-712	⑦	591~818	0.49	11		93	370
	A1D5C-612	⑥	121~172	0.27	1.5		84	70									
	A1D5C-712	⑦	126~192	0.31	1.5		84	70									
630	A1D6C-112	①	47~103	0.37	1.5		88	95	1000	A1D10F-312	③	210~472	0.52	5.5		93	340
	A1D6C-212	②	97~167	0.37	1.5		87	95		A1D10F-412	④	429~613	0.43	5.5		93	340
	A1D6C-312	③	164~220	0.35	1.5		86	95		A1D10G-512	⑤	546~760	0.46	7.5		95	370
	A1D6D-412	④	189~274	0.39	2.2		83	100		A1D10H-612	⑥	652~900	0.48	11		95	390
	A1D6E-512	⑤	228~321	0.41	3.7		82	105		A1D10I-712	⑦	763~1017	0.52	15		96	460
	A1D6E-612	⑥	254~365	0.43	3.7		84	105									
	A1D6F-712	⑦	281~400	0.50	5.5		85	120									

• Values show performance with a suction bellmouth.

• The noise level value is the value near the highest efficiency point 1 m from the front side of the air inlet. Depending on your usage specification point, noise may increase by about 5dB(A) above the value in the table.

For details, please contact our sales representatives.

In addition, the average noise level beside the casing is about 6 dB(A) lower than the value in the table.

• Use with a maximum air suction temperature of 40°C or below.

If the temperature exceeds 40°C or to suction steam or special gases, please contact us.

# Axial blower · Specifications

## High-pressure series A2D

## For 50Hz

Diameter Ø(mm)	Model	Performance Curve Number	Air Volume (m <sup>3</sup> /min)	MAX Static Pressure (kPa)	Motor		Noise level (dB(A))	Weight (kg)	Diameter Ø(mm)	Model	Performance Curve Number	Air Volume (m <sup>3</sup> /min)	MAX Static Pressure (kPa)	Motor		Noise level (dB(A))	Weight (kg)
					Output (kW)	Poles (P)								Output (kW)	Poles (P)		
300	A2D3A-111	①	22~32	0.22	0.4		79	35	710	A2D7F-111	①	83~194	1.55	5.5		105	180
	A2D3A-311	③	32~42	0.29	0.4		79	35		A2D7H-211	②	135~327	1.70	11		104	220
	A2D3B-711	⑦	49~63	0.32	0.75		82	40		A2D7I-311	③	223~458	1.71	15		104	230
										A2D7J-411	④	411~557	1.47	18.5		103	245
400	A2D4B-111	①	31~64	0.56	0.75		92	55	800	A2D8D-111	①	63~134	0.50	2.2		87	185
	A2D4C-311	③	67~94	0.48	1.5		88	55		A2D8D-211	②	108~217	0.53	2.2		90	185
	A2D4D-511	⑤	100~134	0.55	2.2		88	60		A2D8E-311	③	165~316	0.55	3.7		92	195
	A2D4E-711	⑦	128~176	0.66	3.7		87	70		A2D8F-411	④	300~410	0.47	5.5		89	210
500	A2D5C-111	①	53~83	0.59	1.5		95	70	900	A2D8F-511	⑤	366~480	0.48	5.5		89	210
	A2D5D-211	②	88~120	0.58	2.2		97	70		A2D8G-611	⑥	465~610	0.50	7.5		87	220
	A2D5D-311	③	131~168	0.60	2.2		93	70		A2D8H-711	⑦	507~690	0.58	11		91	255
	A2D5E-411	④	162~208	0.67	3.7		94	80		A2D9E-111	①	80~213	0.65	3.7		97	280
	A2D5F-511	⑤	193~250	0.72	5.5		94	100		A2D9F-211	②	172~350	0.70	5.5		98	290
	A2D5F-611	⑥	202~286	0.76	5.5		95	100		A2D9G-311	③	254~474	0.73	7.5		96	300
630	A2D5G-711	⑦	211~316	0.77	7.5		95	105	A2D9G-411	④	525~611	0.51	7.5		95	300	
	A2D6E-111	①	79~170	1.02	3.7		99	105	A2D9H-511	⑤	574~748	0.68	11		94	330	
	A2D6F-211	②	162~268	1.04	5.5		98	120	A2D9I-611	⑥	670~887	0.74	15		95	360	
	A2D6G-311	③	245~358	1.06	7.5		97	125	A2D9J-711	⑦	730~989	0.78	18.5		98	430	
	A2D6H-411	④	302~425	1.06	11		94	155	A2D10F-211	②	90~370	0.86	5.5		100	330	
	A2D6I-511	⑤	343~490	1.20	15		93	165	A2D10G-311	③	265~540	0.82	7.5		98	330	
	A2D6J-611	⑥	425~550	1.20	18.5		94	175	A2D10H-411	④	537~710	0.68	11		97	370	
									A2D10I-511	⑤	685~890	0.72	15		98	380	
									A2D10J-611	⑥	805~1030	0.76	18.5		99	460	
									A2D10L-711	⑦	931~1180	0.81	30		100	500	

## High-pressure series A2D

## For 60Hz

Diameter Ø(mm)	Model	Performance Curve Number	Air Volume (m <sup>3</sup> /min)	MAX Static Pressure (kPa)	Motor		Noise level (dB(A))	Weight (kg)	Diameter Ø(mm)	Model	Performance Curve Number	Air Volume (m <sup>3</sup> /min)	MAX Static Pressure (kPa)	Motor		Noise level (dB(A))	Weight (kg)	
					Output (kW)	Poles (P)								Output (kW)	Poles (P)			
300	A2D3A-112	①	26~35	0.30	0.4		83	35	710									
	A2D3B-312	③	40~49	0.42	0.75		82	40										
	A2D3C-712	⑦	60~76	0.43	1.5		85	40										
400	A2D4C-112	①	37~80	0.77	1.5		95	55	800	A2D8E-112	①	65~160	0.79	3.7		91	195	
	A2D4D-312	③	87~120	0.68	2.2		91	60		A2D8F-212	②	110~250	0.83	5.5		94	210	
	A2D4E-512	⑤	116~155	0.83	3.7		94	70		A2D8F-312	③	185~376	0.81	5.5		96	210	
										A2D8G-412	④	360~430	0.67	7.5		93	220	
500										A2D8H-512	⑤	440~570	0.70	11		93	255	
	A2D5D-112	①	63~100	0.85	2.2		99	70	A2D8I-612	⑥	560~730	0.73	15		91	270		
	A2D5E-212	②	106~147	0.85	3.7		102	80	A2D8J-712	⑦	580~790	0.84	18.5		95	350		
	A2D5F-312	③	159~214	0.94	5.5		96	100	A2D9F-112	①	97~257	0.94	5.5		101	290		
	A2D5F-412	④	227~244	0.72	5.5		98	100	A2D9G-212	②	207~423	1.03	7.5		102	300		
	A2D5G-512	⑤	265~292	0.82	7.5		99	105	A2D9H-312	③	306~572	1.07	11		100	330		
630										A2D9I-412	④	560~737	0.90	15		99	360	
	A2D6G-112	①	95~205	1.50	7.5		103	125	A2D9J-512	⑤	690~883	0.98	18.5		98	430		
	A2D6H-212	②	195~330	1.51	11		102	155	A2D9L-612	⑥	792~1047	1.07	30		99	470		
	A2D6I-312	③	295~430	1.54	15		101	165	A2D9L-712	⑦	875~1194	1.12	30		102	470		
	A2D6J-412	④	364~515	1.59	18.5		98	175	A2D10F-112	①	100~295	0.91	5.5		100	330		
									A2D10H-212	②	170~480	1.10	11		104	370		
									A2D10I-312	③	320~665	1.18	15		102	380		
									A2D10J-412	④	635~850	0.99	18.5		101	460		
									A2D10L-512	⑤	808~1100	1.05	30		102	500		

- Values show performance with a suction bellmouth.
- The noise level value is the value near the highest efficiency point 1 m from the front side of the air inlet. Depending on your usage specification point, noise may increase by about 5dB(A) above the value in the table.  
For details, please contact our sales representatives.
- In addition, the average noise level beside the casing is about 6 dB(A) lower than the value in the table.
- Use with a maximum air suction temperature of 40°C or below.  
If the temperature exceeds 40°C or to suction steam or special gases, please contact us.



# Custom order products

## ① Type KSB · U100B belt drive series

Compact

High pressure

### Specifications

Model	KSB-H04V	KSB-H07V	KSB-H15V	KSB-H22V	KSB-H37V
Out put (kW)	2.2	3.7	7.5	11	18.5
Frequency (Hz)	50/60				
Max rotation (min <sup>-1</sup> )	4300				
Max air volume (m <sup>3</sup> /min)	18	37	52	64	96
Max static pressure (kPa)	4.70	4.95	5.90	7.80	9.90

Please consult about handling gas and temperature.

### Customizable details

Motor	Wattage,voltage,heat resistant class, commercial goods, explosion proof, increased safety
Parts in contact with gas (shaft, impeller)	Different materials(ie,stainless steel)

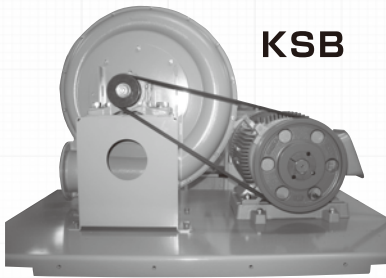

**KSB**

Higher pressure!

The actual product includes a belt cover.

Rotation up max 5,400 min<sup>-1</sup>(special impeller),shaft(labyrinth,etc), bearing(pillow type),JIS-ANSI flange, scaffold frame, optional accessories parts (muffler box,etc)

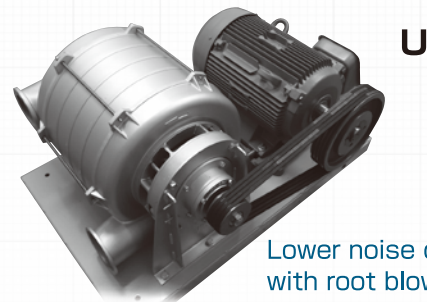

**U**

Lower noise compared with root blower!

Stage up (6,7 stage),sleeve, shaft(sheet packing,etc), JIS/ANSI flange, scaffold frame, optional accessory parts(silencer,etc)

## ② Biaxial blower series

Space saving

Large Airflow

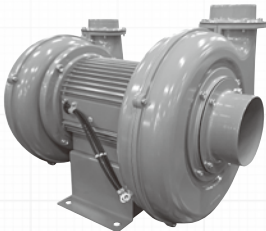

An ideal model when air volume is required in restricted spaces.

### Specifications

Model	EC-75T-16-0213	EC-100T-114-B21	EC-125-16-0213	FS-1500W-110H
Output (kW)	0.4	0.75	1.0	1.5
Casing 1	EM-75T4	EC-100T	EC-125	Special (FS-750 base)
Casing 2	EC-63T	EM-100T7	EM-75T4	Special (FS-750 base)
Usage	Dry dehumidifier	Dry dehumidifier	Dry dehumidifier	Large vehicle AC

### Customizable details

Motor	Pole,output,voltage,heat resistant class difference/commercial goods
Parts in contact with the gas (shaft, impeller)	Various materials(steel, stainless steel,etc)/ Various shapes(E or AH series casing and impeller)/ Double sided (left-right casing and impellers)
Others	Optional parts:can include mounting flange,etc

## Stirring blower series

Compact

Large Airflow

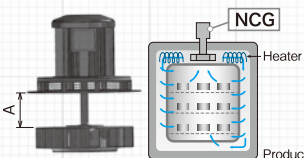

Ideal for internal furnace air stirring

### Specifications

Model	NCG-H04HT	NCG-H07HT	NCG-H10HT	NCG-H15HT	NCG-H22HT	NCG-H37HT
Output (kW)	0.4	0.75	1.0	1.5	2.2	3.7
Frequency (Hz)	50/60					
Impeller's material (Airfoil)	AC4B	SPHC				
Max rotation (min <sup>-1</sup> )	200	250				
Max air volume (m <sup>3</sup> /min)	22/26	33/41	42/50	58/71	74/86	100/120
Max static pressure (kPa)	1.00/1.45	1.25/1.80	1.30/1.90	1.45/2.05	1.60/2.30	2.15/3.10
Dimension A (mm)	100					

※The airflow and static pressure values correspond to the AH model(including casing)

### Customizable details

Motor	Voltage, heat resistant class, outdoors specs, explosion proof, increased safety
Parts in contact with the gas (shaft, impeller)	Different materials (ie. stainless steel)
Others	Different dimensions (longer shaft), insulation, air intake temp, casing, suction cone

# Custom order products

## ④ Multistage blower heat resistant sleeve type series

### Specifications

Model	U75-H2HT-620	U75-H3HT-620	U75-H4HT-620	U75-H5HT-620
Output (kW)	0.4		1.0	
Frequency (Hz)	50/60			
Impeller/guide vane material	SPCC			
Max suction temperature (°C)	150			
Max air volume (m <sup>3</sup> /min)	8.1/9.4	8.5/5.9	8.5/8.5	8.7/5.9
Max static pressure (kPa)	2.10/3.00	3.00/4.30	4.00/5.70	4.90/7.10

Model	U100B-H26HT-620	U100B-H35HT-620 U100B-H36HT-620	U100B-H45HT-620 U100B-H46HT-620	U100B-H55HT-620 U100B-H56HT-620
Output (kW)	1.5	1.5 2.2	2.2 3.7	2.2 3.7
Frequency (Hz)	50/60			
Impeller/guide vane material	SPCC			
Max suction temperature (°C)	150			
Max air volume (m <sup>3</sup> /min)	14/16	14/17	15/17	15/18
Max static pressure (kPa)	4.00/5.60	5.80/8.30	7.60/11.0	9.60/13.8

High pressure

Compact

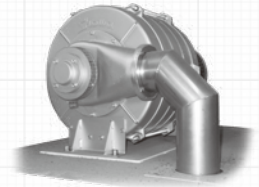

For high temperature gas circulation, supply and exhaust in various factories

### Customizable details

Motor	Voltage, heat resistant class, outdoors spec, explosion proof, increased safety, commercial product(coupling) <sup>※</sup> ※U100B could change to V belt.	
Parts contact with gas (shaft, impeller)	Different materials (ie.stainless steel)	
Others	JIS·ANSI flange, drain, coupling, optional accessories Others	

## ⑤ Cross flow blower

### Specifications

Model	SCF-H37
Output (kW)	3.7
Voltage (V)	200
Frequency (Hz)	50
Max rotation (min <sup>-1</sup> )	1450
Parts in contact with gas (impeller, shaft) material	SUS304

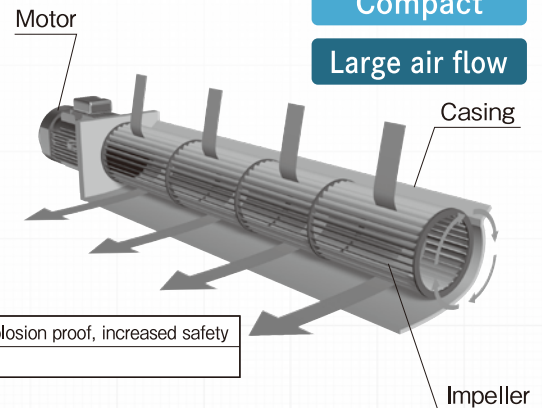

Compact

Large air flow

### Customizable details

Motor	Pole, wattage, voltage, heat resistant class, commercial goods, explosion proof, increased safety
Parts in contact with gas (shaft, impeller)	Different materials (ie.stainless steel)

## ⑥ Powder conveyance series KSB/EP type

Model	KSB-H04P-610	KSB-H07P-610	KSB-H15P-610	KSB-H22P-610	KSB-H37P-610
Output (kW)	0.4	0.75	1.5	2.2	3.7
Frequency (Hz)	50/60				
Casing/Impeller material	Steel/plate				
Max air volume (m <sup>3</sup> /min)	10.5/10.5	16/14.5	24.5/25.5	35/35	44/44
Max static pressure (kPa)	1.70/1.70	1.95/2.05	2.65/2.50	3.00/3.05	3.70/3.65

Model	EP-63S-610 EP-63T-610	EP-75S-610 EP-75T-610	EP-H04-610	EP-H07-610	EP-H10-610	EP-H15-610
Output (kW)	0.1	0.2	0.4	0.75	1.0	1.5
Power supply	Single/three phase		Three phase			
Frequency (Hz)	50/60					
Casing/Impeller material	Steel/plate					
Max air volume (m <sup>3</sup> /min)	5.0/6.0	7.0/8.0	14/15	23.5/19.5	25/20	31/29
Max static pressure (kPa)	0.60/0.80	0.75/1.10	1.15/1.65	1.25/1.80	1.45/2.10	1.70/2.45

Motor	Voltage, heat resistant class, outdoors spec, explosion proof, increased safety,	
Parts in contact with gas (casing, shaft, impeller)	Different materials (ie.stainless steel)	
Others	JIS · ANSI flange, drain, coupling, optional accessories Others	

Compact

Large air flow

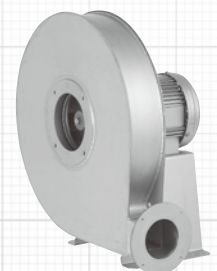

For powder vacuume transfer system

## Custom order products

### ⑦ High temperature Denchoku

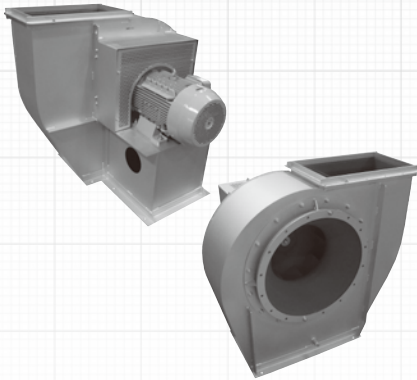

A direct motor shaft connection blower able to handle high temperatures (up to 350°C max).

【Turbo-Type Blower】

Air volume : 220m<sup>3</sup>/min Static pressure : 2.58kPa

Motor : 15 kW / 2P / 50 Hz

■ Intake air temperature : 350°C maximum

■ Shaft bearings : Air cooled

■ Although capable of handling high-temperature gases, the Denchoku configuration (direct motor shaft connection) provides high-efficiency and a compact design.

### ⑧ Agitation blower

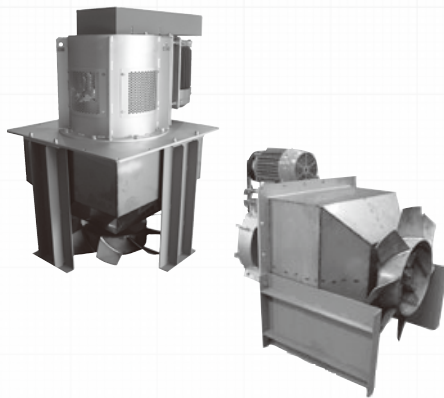

Blower for air agitation inside tempering furnaces.

【Axial Flow Blower】

Air volume : 400m<sup>3</sup>/min Static pressure : 0.50kPa

Motor : 11 kW / 4P / 60 Hz

■ Material : SUS304 for the impeller, shaft, and gas contact parts inside the furnace

■ Intake air temperature : 300°C maximum

■ Impeller diameter :  $\phi$  740mm

■ Shaft bearings : Air cooled

■ An agitation blower that is mounted on the roof of the furnace, with the impeller directed downward.

### ⑨ Coupling turbo-type blower with teflon coating

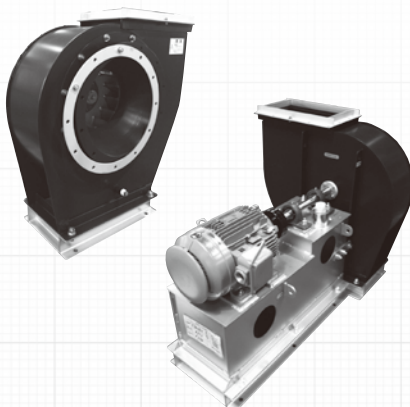

A Teflon-coated blower with excellent anti-corrosion properties.

【Turbo-Type Blower】

Air volume : 30m<sup>3</sup>/min Static pressure : 2.94kPa

Motor : 3.7 kW / 2P / 60 Hz

■ Intended for use in a corrosive environment.

■ The gas contact parts are made from SUS304, and the casing and intake port are Teflon coated.

■ The shaft seal is a Teflon sheet gasket. As well, the casing and shaft bearings base are joined by removable bolts, allowing the casing to be replaced separately.

### ⑩ Furnace agitation axial flow blower

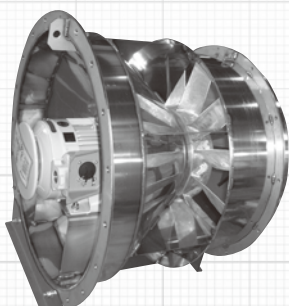

Blower for air agitation inside drying furnaces.

■ Material : Stainless steel

■ Intake air temperature : 150°C maximum

■ Impeller diameter :  $\phi$  630mm

■ Direct motor connection

## Custom order products

### ⑪ Stainless steel sirocco type blower

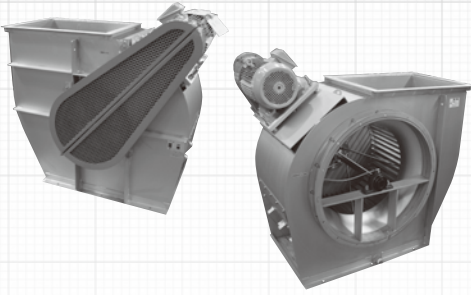

A sirocco type blower for dryers.

【Sirocco】

Air volume : 620m<sup>3</sup>/min Static pressure : 0.3kPa

Motor : 7.5 kW / 4P / 60 Hz

- Material : SUS304 for gas contact parts
- Built to fit space requirements of the customer's equipment.
- The compact design has the motor mounted on the top of the casing.

### ⑫ Engine-driven blower for gas exhaust in emergencies

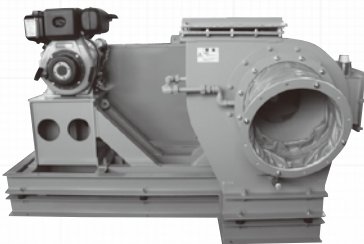

This engine-driven blower can be kept running during power cuts (emergency situations).

【Turbo-Type Blower】

Air volume : 45m<sup>3</sup>/min Static pressure : 2kPa

Engine output : 4.3kW

- Bypass labyrinth seals are used for the shaft seal.  
The bypass labyrinth seal is structured so that high-pressure gases from the shaft seal are suctioned using the negative pressure on the intake side, and this reduces leakage from the shaft seal.
- As well, the blower includes a vibration damping stand (with vibration damping rubber) and an intake/exhaust expansion joint (made of nylon tarpaulin).

### ⑬ Wear resistant blower

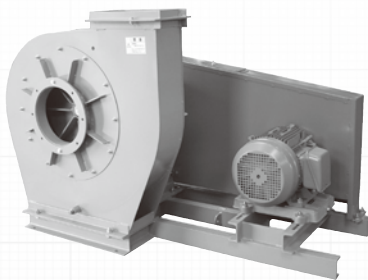

A Radial blade Type blower designed to resist wear.

【Radial blade Type Blower】

Air volume : 31m<sup>3</sup>/min Static pressure : 1.75kPa

Motor : 3.7 kW / 4P / 50 Hz

- Casing : Wear resistant thermal spraying on the inside A chrome-based alloy is thermal sprayed to 0.1 mm thickness.
- Impeller : With wear resistant thermal spraying.  
Hard-faced layers made using tungsten carbide rods are used in the airflow sections.
- The entire intake port side can be removed.
- The casing and shaft bearings stand can also be detached.  
The casing can be replaced when worn.

### ⑭ Wind Tunnel experimental equipment

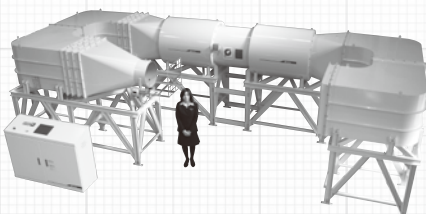

This wind tunnel uses a 900 mm-diameter axial flow blower with a "Kairyu" adjustable fan blade impeller.  
(Outline dimensions: 8.3 m x 3.2 m)

The axial flow blower with a "Kairyu" adjustable fan blade impeller is highly efficient and delivers a large airflow. Honeycomb meshes and other wire meshes and straightening plates are used to correct the airflow and ensure cross-sectionally uniform airflow inside the tunnel. The diameter of the exhaust port is 500 mm, and the maximum wind speed is 50 m/s (180 km/h).

## Custom order products

### ⑮ Coupling direct drive blower

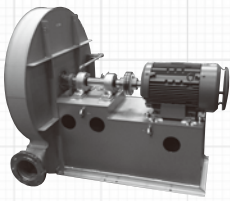

- Higher efficiency than belt-type drive blowers due to the direct transmission of the motor shaft rotation.
- Since the shaft of the blower can be freely designed, there is a wide design range for shaft seals or sucking high-temperature gas.

### ⑯ Door-type casing

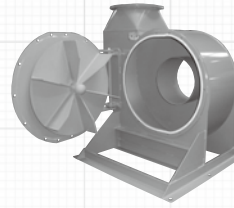

- Cleaning the impeller or casing interior is made easy with a door on the casing side plate that opens and closes.
- Convenient for sucking powders or fine particles.
- Plate type.
- The photo shows a type with direct connection to the motor shaft and the opening on the motor side. For belt drive types, the opening is on the suction port side.

### ⑰ Yagura scaffold



- Since the motor base is over the bearing stand, the installation space of the blower body hardly changes. It is longer in the axial direction.
- The photo shows a B2V Yagura base

### ⑱ Double-suction sirocco blower

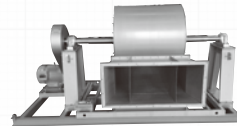

- A double-suction type for air supply with a structure that can suction from both directions in a single unit.
- The photo shows a custom product with long wings for bearing installation outside the room.
- For sucking hot air

### ⑲ Unit body insulation

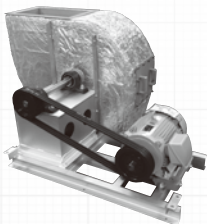

- Rock wool insulation material on the blower body.
- Reduced noise level from inside the blower.
- For heat-resistant specifications, prevent a drop in heat exchange due to the blower casing. At the same time, prevent accidents like burns.

### ⑳ Water-cooled bearing

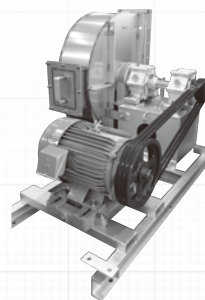

- Use water-cooled bearing to cool the bearing housing when sucking high-temperature air.

### ㉑ Double anti-vibration stand

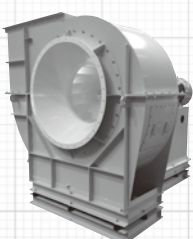

- Anti-vibration rubber absorbs vibrations of the blower body and reduces vibration transmission to the foundation (floor).

### ㉒ Body lagging

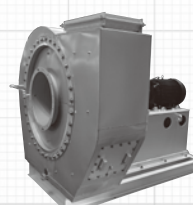

- Prevent heat drops at the casing when high-temperature air is suctioned.
- Reduce noise generated in the main body of loud blowers.

## Contact information

The models listed in this catalog are typical standard models.

We can also manufacture models with performance and shapes are other than those listed, as custom orders.

We propose the optimum specifications for our customers based on our abundant production and delivery records. Contact us with information such as: air flow, static pressure, intake temperature (regular/maximum), intake gas type, voltage / frequency, usage or applications; our sales engineers will respond in your language.

Please feel free to contact us.

### Overseas sales engineering department

**Address** 1-25 Shinden-Kitamachi, Daito-City, 574-0052, Osaka, Japan







**Contact** ☎ +81-72-871-1511 📠 +81-72-870-7243

**E-mail** web-info@showadenki.co.jp

Supported languages (as of October 2020):

English / Spanish / Chinese / Korean /  
Thai / Vietnamese / Indonesian /  
Malaysian / Japanese

### Overseas exclusive dial

 Thailand +66-87-326-2412	 Indonesia +62-811-8759-841	 Vietnam +84-94-990-8822	 Korea +82-10-4874-5710
 Taiwan +886-965-176-277	 China +86-156-2502-1100	 Hong Kong +852-9763-0700	

### Overseas branch introduction

#### Showadenki (Thailand) Co.,Ltd.

**Address** No.71 Soi Chalermprakit Rama 9, Soi 28, Dokmai , Prawet , Bangkok, Thailand 10250

**Contact** ☎ +66-2-053-1899 📠 +66-2-054-1899

**E-mail** sthinquiry@showadenki.co.jp



Showadenki Thailand



#### Showa Denki (Korea) Co.,Ltd.

**Address** A-710 Cheonan Mirae Ace High Tech City,10, Baekseokgongdan 1-ro, Seobuk-gu, Cheonan-si, Chungcheongnam-do

**Contact** ☎ +82-41-906-5710 📠 +82-41-906-5720

**E-mail** skr@showadenki.co.jp



Showa Denki Korea



#### Showa Denki (Taiwan) Co.,Ltd.

**Address** No.82, Liaoyang 4th Street, Beitun Dist., Taichung City, Taiwan

**Contact** ☎ +886-4-2241-3005 📠 +886-4-2241-3006

**E-mail** stw@showadenki.co.jp



Showa Denki Taiwan

# Website Introduction

Product Site  
Top page



showadenki

Corporate Site  
Top page



showadenkigroup

"LEOS"  
(Little bit Engineering of Showa)

Case Studies : Work Environment Improvement



showadenki leos

## Catalog and Manual Downloads



showadenki download

## How to Search

**1** Select Catalog or Instruction Manual

**2** Select Product Category

**3** Search

If you do not know the exact desired item, enter the base of the model.  
Ex: EC-H04

## Download performance curve and dimensional diagrams



showadenki download

## How to Search

**1** Enter the base of the model.

**2** Search

※Click here for the model name explanation.

## Product Showcase Videos on YouTube



showadenki youtube

See product introductions, Windracer simulation runs, and other videos.

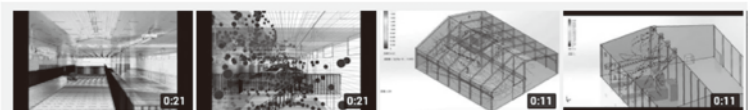



 **Showa Denki Group**